

IBM Copyright Permission #22156

Reprint Courtesy of International Business Machines Corporation, © 1999 International Business Machines Corporation”

The material must be accompanied by the following credit line: “**Reprint Courtesy of International Business Machines Corporation, © 1999 International Business Machines Corporation**”. The credit line normally should appear on the page where the posting appears, either under the title or as a footnote. If the foregoing is inconvenient, the credit line may be placed in a conveniently viewable manner with suitable reference to the places where the material appears.

It is the understanding of **International Business Machines Corporation** that the purpose for which its material is being reproduced is accurate and true as stated in the original request.

Permission to quote from, transmit electronically or reprint/post IBM material is limited to the purpose and quantities originally requested and must not be construed as a blanket license to use the material for other purposes or to reproduce other IBM copyrighted material.

IBM reserves the right to withdraw permission to reproduce copyrighted material whenever, in its discretion, it feels that the privilege of reproducing its material is being used in a way detrimental to its interest or the above instructions are not being followed properly to protect its copyright.

No permission is granted to use trademarks of **International Business Machines Corporation** and its affiliates apart from the incidental appearance of such trademarks in the titles, text, and illustrations of the named publications. Any proposed use of trademarks apart from such incidental appearance requires separate approval in writing and ordinarily cannot be given. The use of any IBM trademark should not be of a manner which might cause confusion of origin or appear to endorse non-IBM products.

THIS PERMISSION IS PROVIDED WITHOUT WARRANTY OF ANY KIND, EITHER EXPRESSED OR IMPLIED, INCLUDING BUT NOT LIMITED TO IMPLIED WARRANTIES OF MERCHANTABILITY AND FITNESS FOR A PARTICULAR PURPOSE.

INTERNATIONAL BUSINESS MACHINES CORPORATION

Dated: January 29, 2014

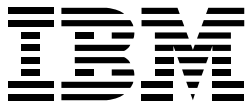

*OS/2 Warp Server
for e-business*
(Course Code WS97)

Master Visuals
ERC1.0

IBM Learning Services
Worldwide Certified Material

Publishing Information

This publication has been produced using BookMaster (Program Number 5668-015), the Document Composition Facility (Program Number 5748-XX9), and Freelance 2.1 for Windows. It was printed on the IBM 3820 Page Printer.

Trademarks

IBM® is a registered trademark of International Business Machines Corporation.

The following are trademarks of International Business Machines Corporation in the United States, or other countries, or both:

AIX	LAN Distance	Presentation Manager
FFST/2	Netfinity	SystemView
First Failure Support Technology/2	Netfinity Manager	VoiceType

Freelance and Lotus Notes are trademarks of Lotus Development Corporation in the United States, or other countries, or both.

Java and all Java-based trademarks and logos are trademarks of Sun Microsystems, Inc. in the United States, countries, or both.

Microsoft, Windows, Windows NT, and the Windows logo are trademarks of Microsoft Corporation in the United States, other countries, or both.

ActionMedia, LANDesk, MMX, Pentium and ProShare are trademarks of Intel Corporation in the United States, other countries, or both.

Other company, product, and service names may be trademarks or service marks of others.

September 1999 Edition

The information contained in this document has not been submitted to any formal IBM test and is distributed on an "as is" basis without any warranty either express or implied. The use of this information or the implementation of any of these techniques is a customer responsibility and depends on the customer's ability to evaluate and integrate them into the customer's operational environment. While each item may have been reviewed by IBM for accuracy in a specific situation, there is no guarantee that the same or similar results will result elsewhere. Customers attempting to adapt these techniques to their own environments do so at their own risk. The original repository material for this course has been certified as being Year 2000 compliant.

© Copyright International Business Machines Corporation 1999. All rights reserved.
This document may not be reproduced in whole or in part without the prior written permission of IBM.
Note to U.S. Government Users — Documentation related to restricted rights — Use, duplication or disclosure is subject to restrictions set forth in GSA ADP Schedule Contract with IBM Corp.

Contents

Course Presentation Material Overview	xi
--	----

Units

Unit 1. Overview of OS/2 Warp Server for e-business	1-1
Objectives	1-2
OS/2 Base Operating System	1-3
Logical Volume Manager	1-4
Journalized File System	1-5
Year 2000 and the Euro	1-6
Updated Desktop	1-7
File and Print Sharing Services	1-8
TCP/IP Services	1-9
Netscape Communicator	1-10
Java Support	1-11
Neighborhood Browser Enabler	1-12
Windows NT User Account Manager	1-13
LDAP Client Support	1-14
I20 Support	1-15
Tivoli Management Agent	1-16
Lotus Domino Go Webserver and IBM WebSphere Application Server	1-17
Personally Safe- Sound Backup and	1-18
Advanced Print Services	1-19
Remote Access Services	1-20
Additional New Features	1-21
Replaced or Discontinued Components (1 of 2)	1-22
Replaced or Discontinued Components (2 of 2)	1-23
Unit Summary	1-24
Unit 2. Planning OS/2 Warp Server for e-business Installation	2-1
Objectives	2-2
System Requirements (1 of 2)	2-3
System Requirements (2 of 2)	2-4
Hard Disk Space Requirements	2-5
Keyboards Supported during Installation (1 of 2)	2-6
Keyboards Supported During Installation (2 of 2)	2-7
Display and Graphics Adapter Considerations	2-8
Installation Strategy	2-9
Unit Summary	2-10

Unit 3. Installing and Configuring OS/2 Warp Server for e-business	3-1
Objectives	3-2
Server Packaging	3-3
Server Packaging	3-4
Hard Disk Requirements	3-5
ClientPack (2 CD-ROMs)	3-6
Client Connect Pak Matrix	3-7
Year 2000 and Euro	3-8
Java Support	3-9
JFS Utilities	3-10
LVM (Replaces fdisk)	3-11
System Configuration (1 of 2)	3-12
System Configuration (2 of 2)	3-13
Default Printer	3-14
Primary Display Drivers	3-15
Setup and Installation (1 of 2)	3-16
Setup and Installation (2 of 2)	3-17
Setup and Installation — Information	3-18
Select Services	3-19
File and Print	3-20
Configuration	3-21
File and Print	3-22
Network Adapters	3-23
Remote IPL (1 of 2)	3-24
Remote IPL (2 of 2)	3-25
386HPFS	3-26
Autostart	3-27
Remote Access Services	3-28
Administrator ID / Password	3-29
TCP/IP Services	3-30
Netscape Communicator	3-31
LDAP Toolkit	3-32
Tivoli Management Agent	3-33
Backup and Recovery (PSnS)	3-34
Advanced Print Services	3-35
Books	3-36
Error Logging	3-37
Adapter and Protocol Services	3-38
Configuration Complete	3-39
Tuning Assistant	3-40
Installing Additional Components	3-41
Unsupported Tools	3-42
Productivity Aids (\CID\SERVER\BMLS\IBM500P1)	3-43
Back up Critical Files	3-44

Emergency Boot Disk	3-45
Unit Summary	3-46
Unit 4. Administering Common Tasks in OS/2 Warp Server for e-business	4-1
Objectives	4-2
Initial Network Administration Tasks	4-3
Managing Network Services	4-4
Network Service Status	4-5
Guidelines for Stopping and Pausing Network Services	4-6
Stopping and Pausing a Network Service	4-7
Command Line Access	4-8
LAN Logon (1 of 2)	4-9
LAN Logon (2 of 2)	4-10
Setup the Domain	4-11
USERS	4-12
GROUPS	4-13
Access Control Profile	4-14
Access Permissions Applicable to Resource Types	4-15
Types of Resources	4-16
Sharing Network Resources	4-17
Directory Limits (386 HPFS)	4-18
Network Printing	4-19
Logical Volume Management Tool - Logical View	4-20
Physical Disk View	4-21
Install Boot Manager	4-22
Create Volume	4-23
Create Partition	4-24
Commit Changes	4-25
LVM Overview	4-26
LVM Components	4-27
Physical View via LVM	4-28
Physical View via LVMGUI	4-29
Logical View via LVM	4-30
Logical View via LVMGUI	4-31
Notes	4-32
JFS System Structure	4-33
I-Node	4-34
Aggregate Structure	4-35
Logical Volume View	4-36
Personally Safe and Sound (PSnS)	4-37
Backup Method	4-38
Source Drives	4-39
Storage Devices	4-40
Backup Sets	4-41

Determine Security Guidelines	4-42
Applications as a Resource	4-43
Considerations	4-44
Remote Execution	4-45
IP Address Assignment	4-46
File Transfer	4-47
TCP/IP Printing	4-48
Remote Access	4-49
Unit Summary	4-50

Unit 5. Administering Installation Specific Tasks in OS/2 Warp Server for e-business	5-1
Objectives	5-2
Setting Up the Exporter	5-3
Setting Up the Importer	5-4
DCDB Replication	5-5
DCDB Exporter	5-6
DCDB Importer	5-7
Tuning	5-8
Tuning Assistant (1 of 11)	5-9
Tuning Assistant (2 of 11)	5-10
Tuning Assistant (3 of 11)	5-11
Tuning Assistant (4 of 11)	5-12
Tuning Assistant (5 of 11)	5-13
Tuning Assistant (6 of 11)	5-14
Tuning Assistant (7 of 11)	5-15
Tuning Assistant (8 of 11)	5-16
Tuning Assistant (9 of 11)	5-17
Tuning Assistant (10 of 11)	5-18
Tuning Assistant (11 of 11)	5-19
Parameters For Servers and Clients	5-20
Lan Administration GUI (1 of 2)	5-21
Lan Administration GUI (2 of 2)	5-22
Parameters (1 of 12)	5-23
Parameters (2 of 12)	5-24
Parameters (3 of 12)	5-25
Parameters (4 of 12)	5-26
Parameters (5 of 12)	5-27
Parameters (6 of 12)	5-28
Parameters (7 of 12)	5-29
Parameters (8 of 12)	5-30
Parameters (9 of 12)	5-31
Parameters (10 of 12)	5-32
Parameters (11 of 12)	5-33
Parameters (12 of 12)	5-34

View and Close Open Files	5-35
View and Delete Active Sessions	5-36
Performance Statistics	5-37
Perform Auditing Tasks	5-38
Manage Error Logs	5-39
Schedule Tasks	5-40
Configure and Use an Uninterruptible Power Supply Service	5-41
Integrate DLS/Win3.1	5-42
Integrate Win98/98 and NT Clients	5-43
Add NT Servers to OS/2 Warp Server Domain	5-44
Overview	5-45
Protocols Supported	5-46
RIPL Process	5-47
RPL.MAP	5-48
CNF Files	5-49
FIT Files	5-50
NDISDD.PRO	5-51
RIPLINST	5-52
Creating or Changing a Remote IPL Client	5-53
Deleting a Remote IPL Client	5-54
Customizing Clients	5-55
REXX Support	5-56
Unit Summary	5-57
Unit 6. Migrating an Existing System to OS/2 Warp Server for e-business	6-1
Objectives	6-2
Migration Roadmap	6-3
Understanding Different Options for Migration	6-4
Data Gathering (1 of 4)	6-5
Data Gathering (2 of 4)	6-6
Data Gathering (3 of 4)	6-7
Data Gathering (4 of 4)	6-8
File Systems	6-9
Does Your Software Meet the Requirements for Migration?	6-10
Data Gathering	6-11
Special Considerations/Caveats (1 of 9)	6-12
Special Considerations/Caveats (2 of 9)	6-13
Special Considerations/Caveats (3 of 9)	6-14
Special Considerations/Caveats (4 of 9)	6-15
Special Considerations/Caveats (5 of 9)	6-16
Special Considerations/Caveats (6 of 9)	6-17
Special Considerations/Caveats (7 of 9)	6-18
Special Considerations/Caveats (8 of 9)	6-19
Special Considerations/Caveats (9 of 9)	6-20

Preparation Setup	6-21
Tools for the Preparation	6-22
Perform a Test Installation	6-23
Evaluate Disk Utilities and Customer Written Tools	6-24
Configuration	6-25
Configuration Files	6-26
Back up Your System	6-27
The SRVBU Utility	6-28
LAN Server Management Tools (LSMT)	6-29
Prepare for Disaster Recovery	6-30
Remove Remote Access Services	6-31
Remove Local Security	6-32
Back Up Directory Limits	6-33
Back Up Access Control Information	6-34
Save the DCDB	6-35
Remove HPFS Access Controls	6-36
Boot-Time Considerations	6-37
Deactivate Fault Tolerance	6-38
Preparation	6-39
Preparing the Migration	6-40
Performing the Migration	6-41
Under the Covers	6-42
Finishing the Migration	6-43
Migration Methodology	6-44
Preparing New Hardware	6-45
Supported Hardware	6-46
Testing	6-47
Suggested Hardware	6-48
Backup and Contingency	6-49
Migration Strategy	6-50
Installation	6-51
Preparing the CID Installation	6-52
The Installation Steps	6-53
Principles of CID	6-54
LCU Server	6-55
Setting Up a LCU Code Server	6-56
LAN CID Utility	6-57
Software Distribution Managers	6-58
Assumptions	6-59
Preparing the Code Server	6-60
Preparing the Code Server	6-61
Overview of Installation Steps	6-62
Preparation Phase	6-63
Base OS/2 Installation —Phase One	6-64

Installation — Phase Two	6-65
Principle Applications	6-66
Other OS/2 Warp Server Applications	6-67
New Applications	6-68
Final Phase — Cleanup	6-69
CID Installation Parameters	6-70
Create Maintenance System (SEMAINT)	6-71
386 HPFS File System Access (THIN386)	6-72
Logical Volume Manager (LVM) Issues	6-73
Install Base OS/2 Operating System (SEINST)	6-74
Multiprotocol Transport Services (MPTS)	6-75
File System Redirection (1 of 6)	6-76
LCU Installation (CASINSTL)	6-77
Installation — Phase One (1 of 6)	6-78
Installation — Phase One (2 of 6)	6-79
Installation — Phase One (3 of 6)	6-80
Installation — Phase One (4 of 6)	6-81
Installation — Phase One (5 of 6)	6-82
Installation — Phase One (6 of 6)	6-83
Unit Summary	6-84
Unit 7. Resolving Problems	7-1
Objectives	7-2
Initial Problem Documentation	7-3
Installation Log Files (1 of 2)	7-4
Installation Log Files (2 of 2)	7-5
Application-Specific Logs	7-6
Identifying Server Component Problems	7-7
Determine Appropriate Technical Support	7-8
Invoke Appropriate Support Assistance	7-9
Information	7-10
Contacts, Reporting, Logging	7-11
URLs	7-12
System Trace Facility	7-13
Trace Point Types (1 of 2)	7-14
Trace Point Types (2 of 2)	7-15
Groups	7-16
Types	7-17
Strace Facility (Performance Tracing)	7-18
CONFIG.SYS	7-19
IPTRACE	7-20
NETSTAT Command	7-21
SMB Trace Tool	7-22
Process Dump Facility	7-23

PROCDUMP (1 of 2) 7-24
PROCDUMP (2 of 2) 7-25
PDUMPSYS, PDUMPUSR 7-26
System Dump Facility 7-27
Debug Kernel 7-28
Installing Fixpacks 7-29
Driver Updates (IBM and Third Party) 7-30
Review Fixpack Information (Readme) 7-31
Choose Install Method and Install Fixpacks 7-32
Additional PD Training 7-33
Unit Summary 7-34

Course Presentation Material Overview

Included in this package are landscape, black and white paper copies of each of the student visuals included in the Student Notebook. The paper copies are to be used to reproduce overhead transparencies required to teach the course. It is recommended that black-on-clear transparencies be used to reproduce the package.

In addition to the student visuals, a welcome visual SHOULD be included. To ensure that each student is attending the correct course for which they originally enrolled, the welcome visual should be used to provide the student with the course name and course code upon entering the classroom.

It is advised that upon checking out the classroom prior to the start of class, there be two overhead projectors in the classroom. This will guarantee that there is a working overhead projector available at all times for the duration of the class.

The paper copies and the transparencies created from the paper copies are the property of IBM. By way of protecting our intellectual properties, neither the paper copies nor the transparencies should be given to anyone other than a course certified instructor. The copies are not to be used for any purpose other than teaching the course. The security of this package and the products created as a result of this package are the responsibility of the course certified instructor.

Unit 1. Overview of OS/2 Warp Server for e-business

Objectives

After completing this unit, you should be able to describe the following features of OS/2 Warp Server for e-business:

- OS/2 Base Operating System
- Logical Volume Manager
- Journaled File System
- Year 2000 and the Euro
- Updated Desktop
- File and Print Sharing Services
- TCP/IP Services
- Netscape Communicator
- Java Support
- Neighborhood Browser Enabler
- Windows NT User Account Manager
- LDAP Client Support
- I2O Support
- Tivoli Management Agent
- Lotus Domino Go Webserver
- IBM WebSphere Application Server
- Personally Safe 'n' Sound Backup and Recovery
- Advanced Print Services
- Remote Access Services
- Additional New Features
- Replaced or Discontinued Components

OS/2 Base Operating System

- The base operating system for OS/2 Warp Server for e-business is an advanced, multitasking, 32-bit operating system that runs DOS, Windows, and OS/2 16-bit and 32-bit applications and utilizes SMP hardware configurations.

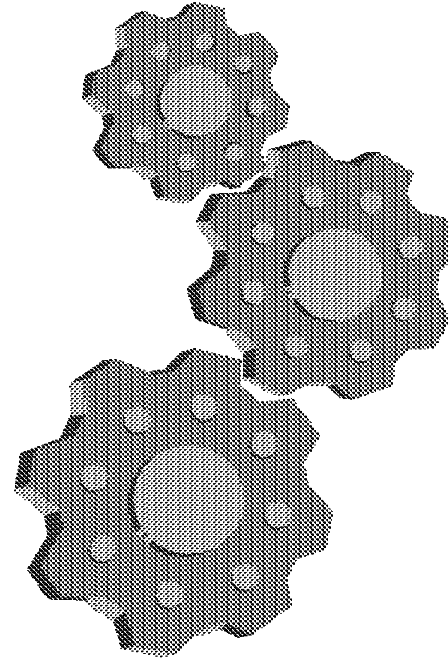

Logical Volume Manager

- The Logical Volume Manager (LVM) provides flexibility for configuring and managing disk drives on your system. LVM replaces the Fixed Disk Utility (FDISK). Disk drives and partitions are configured as logical volumes with a new set of utilities, which support the following enhancements:
 - The drive letter for a disk volume is explicitly assigned when the volume is added, and it is persistent across OS/2 system restarts.
 - A disk volume drive letter can be changed at any time; however, drive letters assigned to operating system volumes should not be changed.
 - Under most conditions, OS/2 does not need to be rebooted after a disk volume drive letter is added or changed.
 - The disk volume drive letters do not need to be contiguous.
 - CD-ROM drive letters can remain unchanged when disk volumes are added.
 - LAN drive letter assignments can remain unchanged when disk volumes are added.
 - Logical volumes can span multiple partitions and physical disks.

Journalled File System

- **The Journalled File System (JFS) is a scalable, 32-bit, performance-oriented file system. To facilitate quick recovery and restart after system failures, JFS uses database journaling techniques, enabling it to restore file systems quickly, which contribute to improved server availability. JFS raises the previous file-size limit of two gigabytes (GB) to two terabytes (TB). The partition size limit is raised from 64 GB to 2 TB. JFS volumes can be increased in size, using Logical Volume Manager (LVM), without having to be reformatted.**

Year 2000 and the Euro

- **OS/2 Warp Server for e-business is fully enabled to support the Year 2000 (Y2K) and euro currency transitions.**
- **The new currency in Europe goes by the name euro. The euro is the monetary unit of the European Monetary Union (EMU) that was introduced alongside national currencies on the first of January 1999. The original members of the EMU are Austria, Belgium, Finland, France, Germany, Ireland, Italy, Luxembourg, the Netherlands, Portugal, and Spain. The national currencies of these countries have a fixed exchange rate with the euro, and will be withdrawn after a transition period, which is planned for completion in 2002.**
- **Support for the euro sign as the currency symbol is available when you specify country information during the installation process.**

Updated Desktop

- The Desktop in OS/2 Warp Server for e-business is based on the Desktop of OS/2 Warp 4. In addition, new icons are on the Desktop, and some existing icons are in a different location than they were in previous versions of OS/2 Warp Server. Take a few minutes after installing OS/2 Warp Server for e-business to become familiar with the new Desktop. Refer to *OS/2 Desktop Guide* for more information about the Desktop.

File and Print Sharing Services

- File and Print Sharing Services enables the server to share directories, printers, and serial devices across a local area network (LAN).

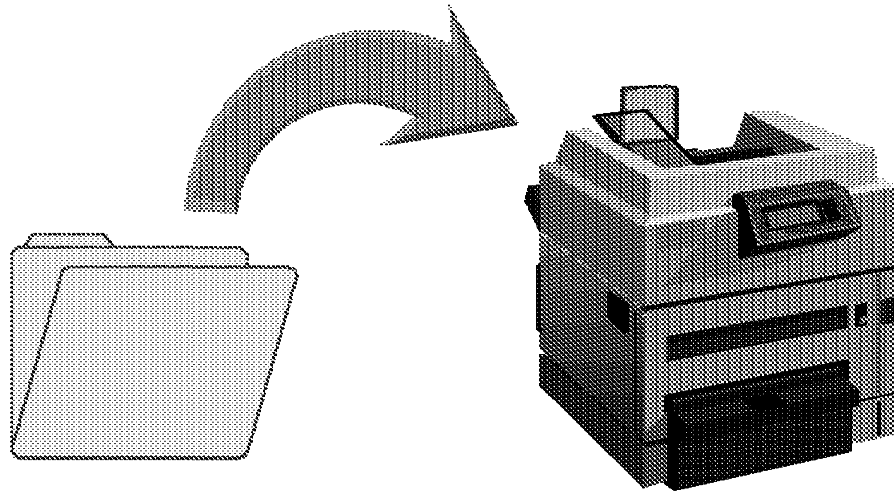

TCP/IP Services

- TCP/IP Services enables the server to distribute the TCP/IP Internet protocol configuration to client workstations. Highlights of the TCP/IP services include:
 - Dynamic Host Configuration Protocol (DHCP) enhancements, which include Remote IPL (RIPL) support and BootP server capability
 - Dynamic Domain Name Server (DDNS) enhancements, which enable the network administrator to more easily manage IP addresses
 - Improved buffer management, resulting in increased performance
 - Improved printer streaming and printer security

Netscape Communicator

- **Netscape Communicator 4.04b lets you access and navigate the Internet with Netscape Navigator, send and receive e-mail with Netscape Messenger, keep track of the latest postings in your favorite newsgroups with Netscape Collabra, and create your own Web pages with Netscape Composer. Some applications and services, such as those found at IBM Software Choice, use the browser as a graphical user interface (GUI) for installing, uninstalling, or updating other software programs.**

Java Support

- The OS/2 Warp Developers Kit, Java Edition, Version 1.1.7 delivers a full implementation of Java, including both the run-time and development packages. This release improves performance and provides euro support. Significant enhancements in graphics, throughput, and scalability set new standards for Java Virtual Machine (JVM) performance.

Neighborhood Browser Enabler

- **The Neighborhood Browser Enabler is an OS/2 Warp Server for e-business service that functions as a master browser for Windows clients. The master browser service permits OS/2 Warp Server for e-business domain resources to be viewed and shared from the Windows NT 4.0, Windows 98, and Windows 95 Network Neighborhood.**

Windows NT User Account Manager

- **The Windows NT User Account Manager eases the management of user and group accounts in a heterogeneous server environment. This feature allows user and group accounts that are defined and managed in the OS/2 Warp Server domain to be replicated to a Windows NT 4.0 server.**

LDAP Client Support

- OS/2 Warp Server for e-business supports the Lightweight Directory Access Protocol (LDAP), a standards-based Internet directory protocol.
- The OS/2 LDAP Client Toolkit for C and Java Version 1.0 is for C and Java programmers who want to enable new or existing applications to access, search, and update LDAP servers, using LDAP V2 or LDAP V3 protocols.

I2O Support

- **OS/2 Warp Server for e-business helps simplify the attachment of new devices. I2O is an industry-standard architecture that defines a new interface between a processor and I/O adapters. This specification provides for movement of function from the system CPU to the adapter card. Use of I2O, either on the system board or as an adapter in servers, reduces the CPU load, which helps increase system throughput. OS/2 Warp Server for e-business supports I2O for SCSI adapters and for ethernet and token-ring LAN adapters.**

Tivoli Management Agent

- **The Tivoli Management Agent (TMA) extends the client/server hierarchy and enhances the scalability of a Tivoli Management Environment (TME). TME is a systems management tool for enterprise-wide, heterogeneous networks. The TMA increases the number of resources that can be managed and, at the same time, enables those resources to be used more efficiently.**
- **Besides providing full functionality down to the endpoints, the TMA reduces the physical requirements to manage a system. The TMA is a replacement for the SystemView agent and supports OS/2 using TCP/IP.**

Lotus Domino Go Webserver and IBM WebSphere Application Server

- OS/2 Warp Server for e-business includes Lotus Domino Go Webserver 4.6.2.6. Lotus Domino Go Webserver is a scalable, high-performance Web server that is easy to install and maintain. It includes state-of-the-art security, site indexing capabilities, and support for JDK 1.1.x. Lotus Domino Go Webserver makes it possible to maintain a productive Web presence in a diverse and dynamic environment. After you install Lotus Domino Go Webserver, you can add Java support by installing IBM WebSphere Application Server 1.1. IBM WebSphere Application Server is a plug-in for Lotus Domino Go Webserver and includes:
 - A Java servlet engine that implements the JavaSoft Java Servlet API
 - IBM additions and extensions to the Java Servlet API for enhanced session tracking and personalization
 - Support for JavaServer Pages (JSP), a powerful approach to dynamic Web pages
 - A database connection manager for caching and reusing connections to JDBC-compliant databases
 - Data access JavaBeans (additional Java classes for accessing JDBC-compliant databases)
 - CORBA Support—an object request broker (ORB) and a set of services that are compliant with the Common Object Request Broker Architecture (CORBA)

Personally Safe 'n' Sound Backup and Recovery

- Personally Safe 'n' Sound (PSnS Backup and Recovery) is a powerful backup utility that lets you safeguard your OS/2 system against loss of data. It allows you to set up a Backup Strategy for each activity you perform on your machine. The strategy, once employed, provides protection against all of the likely causes of data loss: user errors, hardware malfunctions, malicious damage, and disasters.
- For more information about using PSnS, refer to *OS/2 Warp Server Backup/Restore User's Guide* and the other online books that come with it. More information is available on the Internet at the following address:

<http://www.software.ibm.com/os/warp/warp-server>

Advanced Print Services

- **Advanced Print Services, also known as Print Services Facility/2 or PSF/2, allows you to print file formats that your printer typically does not support. Advanced Print Services automatically performs data stream transformations to convert the data in a document into the type of data required by the printer. For example, Advanced Print Services can transform a PostScript document into an advanced function presentation (AFP) document that can be printed on a high-speed IBM printer, or it can transform an AFP document into one that can be printed on an HP LaserJet printer.**
- **Advanced Print Services lets users send print jobs from computers running OS/2, Windows, DOS, or AIX.**

Remote Access Services

- Remote Access Services, a replacement for LAN Distance, includes a remote access server that allows NetBIOS and point-to-point protocol (PPP) clients, including Microsoft Windows NT, Windows 98, Windows 95, IBM OS/2 Internet Dialer, and IBM 8235 users, to remotely access the LAN. The following services are available:
 - Answering incoming calls to establish connections
 - Routing and filtering data to bridge the Remote Access Client workstation to the LAN
 - Providing security for LAN resources
 - Performing other administrative functions for the wide area network (WAN)
 - Assigning IP addresses with DDNS support
- Remote Access Services allows multiple remote workstations to dial in concurrently and access LAN resources. The number of remote workstations supported is determined by your server's processing power and its communications adapters.

Additional New Features

The following additional features are new with OS/2 Warp Server for e-business:

- Long format option during installation. refer to “Formatting the Installation Volume” on page 32 for more information.
- CHKINST.EXE²software sniffer² utility checks the system prior to installation to determine what preparation is required and then reports the results.
- Increase in maximum number of ACLs, open files, connections, searches, and shares. The maximum number of ACLs for the Journaled File System (JFS) is limited only by available disk space. The following capacity parameters in the server section of the IBMLAN.INI file have been increased:
 - maxopens
 - maxsearches
 - maxconnections
 - maxshares
- These changes increase the number of users, files, searches, and shares the server can maintain. refer to *Performance Tuning* for more information.

Replaced or Discontinued Components (1 of 2)

- The following components, previously installed with OS/2 Warp or OS/2 Warp Server, are replaced in OS/2 Warp Server for e-business:
 - Fixed Disk Utility (FDISK.COM), replaced by Logical Volume Management Tool (LVM.EXE)
 - Fixed Disk Presentation Manager Utility (FDISKPM.EXE), replaced by Logical Volume Manager Graphical User Interface (LVMGUI.CMD)
 - Java 1.0, replaced by Java 1.1.7
 - Pulse, replaced by CPU Monitor (CPUMON)
 - LAN Distance, replaced by Remote Access Services
 - SystemView Agent (Netfinity TME 10), replaced by Tivoli Management Agent (TMA)

Replaced or Discontinued Components (2 of 2)

- The following components, previously installed with OS/2 Warp or OS/2 Warp Server, are not part of OS/2 Warp Server for e-business:
 - Password Coordinator
 - Network Signon Coordinator
 - BonusPak
 - OS/2 Warp Tutorial
 - OpenDoc
 - WarpGuide
 - VoiceType
 - Hibernate (Trapdoor)
 - Novell NetWare Client for OS/2
 - Dual boot is not supported
 - Easy Path installation
 - Mobile File Sync
 - PCOMM Lite 4.1
 - Keyworks
 - HP JetAdmin
 - Installation from diskettes, replaced by installation from CD
 - Remote client installation is not supported

Unit Summary

You should now be able to describe the following features of OS/2 Warp Server for e-business:

- OS/2 Base Operating System
- Logical Volume Manager
- Journaled File System
- Year 2000 and the Euro
- Updated Desktop
- File and Print Sharing Services
- TCP/IP Services
- Netscape Communicator
- Java Support
- Neighborhood Browser Enabler
- Windows NT User Account Manager
- LDAP Client Support
- I2O Support
- Tivoli Management Agent
- Lotus Domino Go Webserver
- IBM WebSphere Application Server
- Personally Safe 'n' Sound Backup and Recovery
- Advanced Print Services
- Remote Access Services
- Additional New Features
- Replaced or Discontinued Components

Unit 2. Planning OS/2 Warp Server for e-business Installation

Objectives

After completing this unit, you should be able to:

- Determine OS/2 Warp Server for e-business features to be installed
- Select desired features from list of available features
- Determine if the requirements for all desired features have been met
- Anticipate and resolve any potential ramifications of OS/2 components that will be deleted during installation (OpenDoc, VoiceType, Ask PSP, and so forth)
- Create a final list of OS/2 Warp Server for e-business features to be installed and their requirements
- Determine other products to install
- Develop an Installation Strategy
- Identify existing systems to be migrated
- Identify and gather third-party hardware support diskettes, adapter device drivers, and peripheral device drivers (if necessary)
- Determine overall installation sequence and strategy

System Requirements (1 of 2)

- To install OS/2 Warp Server for e-business and use its services on the server, you need at least the following minimum hardware:
 - One or more Intel-compatible Pentium or higher processors with a speed of at least 133 MHz.
 - Note: A multiprocessor system must either comply with the Intel Multiprocessor Specification, Version 1.4 or 1.1, or it must be one of the following computers, each of which has its own proprietary SMP architecture:
 - Compaq Proliant 2000
 - Tricord PowerServer, models 30 and 40
 - IBM PC Server 720
 - A minimum of 32 MB of random access memory (RAM), but 64 MB or more provides better performance, depending on which services are installed.

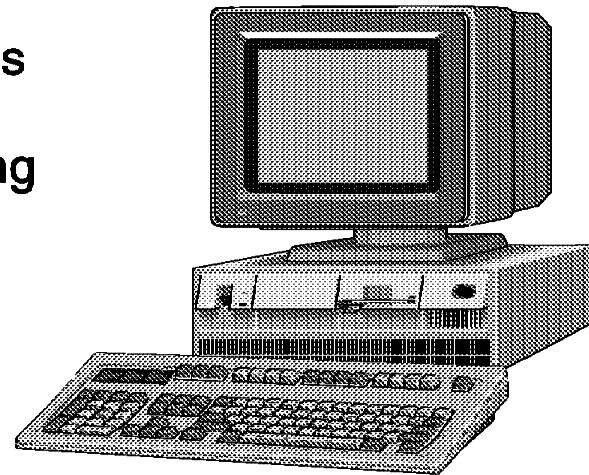

System Requirements (2 of 2)

- A minimum of 120 MB of available hard disk space for the base operating system. A minimum of 200 MB is required for the base operating system and all default installation items. A total of 500 MB is recommended for a typical installation, depending on which services and components are installed. For installation requirements of services and components, refer to the table in “Hard Disk Space Requirements”.
- A 1.44 MB, 3.5-inch diskette drive, configured as drive A.
- A 640 x 480 (16-color) or higher resolution VGA display.
- An IBM-compatible mouse.
- A CD-ROM drive supported by OS/2.
- A LAN adapter card supported by MPTS.
- Remote Access Services requires the supported remote access adapters, which are a subset of the supported MPTS LAN adapters.
- A modem that supports speeds of 9600 bps or higher, if you plan to use Remote Access Services.
- An Internet-enabled LAN or a modem, if you plan to use the Internet.

Hard Disk Space Requirements

Note: The requirements in this section are based on information available at publication time.

Service	Number of Megabytes (MB)
Default installation: OS/2 base operating system plus default components	120.0
All optional OS/2 components	180.0
File and Print Sharing Services	15.0
TCP/IP Services	30.0
Remote Access Services	6.0
Netscape Communicator	11.0
Tivoli Management Agent	1.5
Personally Safe 'n' Sound	7.2
LDAP Services Toolkit	4.2
Advanced Print Services	54.0
First Failure Support Technology (FFST) 1.2	0.1
Online Books	10.0
Total (if all components and services are installed)	439.0

Keyboards Supported during Installation (1 of 2)

- For SBCS versions of OS/2 Warp Server for e-business, code page 850 is the only code page that is supported during the first phase of the installation process or if you start the system from utility diskettes. As a result, you must select one of the Latin-1 keyboards, even if you normally select a non-Latin-1 keyboard. You can still set the country code to any valid country. This setting may affect the default country and keyboard settings used later in the installation process, including those used by the Logical Volume Management Tool (LVM), and for command line processing when the system is booted from utility diskettes. However, later in the installation, you can specify your preferred country and keyboard settings.

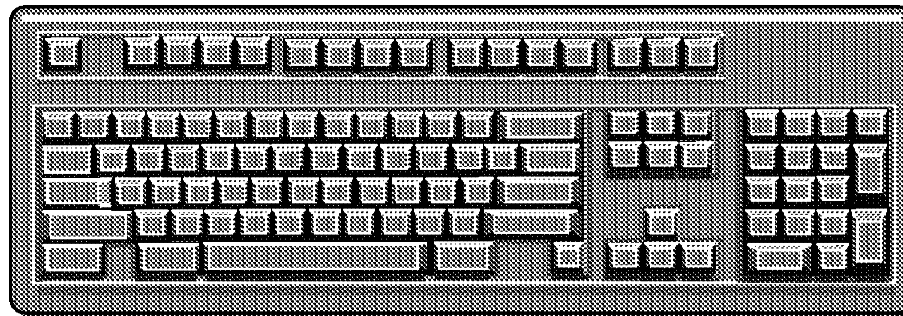

Keyboards Supported during Installation (2 of 2)

- These keyboards are supported during the first phase of OS/2 Warp Server for e-business installation

Country Code	Country Name
be	Belgium
br	Brazil
cf	Canadian French
dk	Denmark
fr	France
gr	Germany
it	Italy
la	Latin America
nl	Netherlands
no	Norway
sf	Swiss French
sg	Swiss German
sp	Spanish
su	Finland
sv	Sweden
uk	United Kingdom
us	United States
ux	US International

Display and Graphics Adapter Considerations

<http://service.software.ibm.com/os2ddpak/index.htm>

- If you find no specific driver for your graphics adapter, consider installing the *Generic VESA Unaccelerated GRADD (GENGRADD)* to obtain Super VGA resolutions and color support.

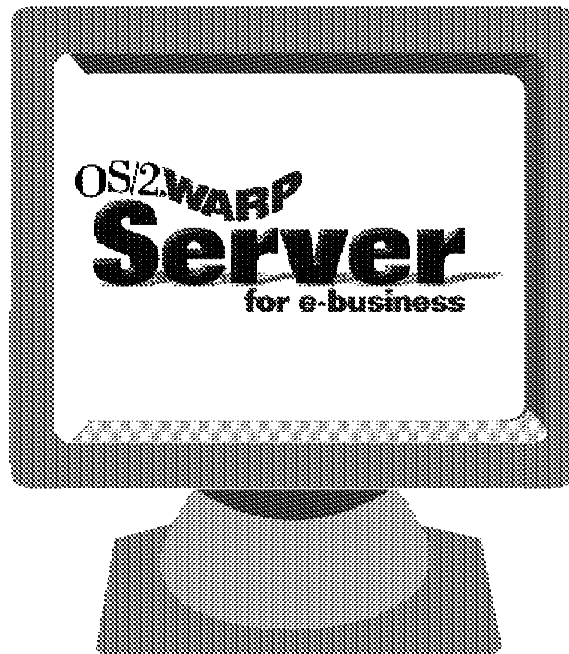

Installation Strategy Discussion

- Review current layout of the servers on the network and the network functions performed by each server
- Determine if all servers meet hardware requirements to support installation of OS/2 Warp Server for e-business and additional functions
- Determine products and services currently installed
- Determine availability and impact of taking existing server down
- Determine volumes, partitions, and file systems
- Plan for PD/PSI requirements
- Identify any existing systems to be migrated
- Identify and gather third-party hardware support diskettes, adapter device drivers, and peripheral device drivers (if necessary)
- Determine overall installation sequence and strategy
- CHKINST
- VCU

Unit Summary

You should now be able to:

- Determine OS/2 Warp Server for e-business features to be installed
- Select desired features from list of available features
- Determine if the requirements for all desired features have been met
- Anticipate and resolve any potential ramifications of OS/2 components that will be deleted during installation (OpenDoc, VoiceType, Ask PSP, and so forth)
- Create a final list of OS/2 Warp Server for e-business features to be installed and their requirements
- Determine other products to install
- Develop an Installation Strategy
- Identify existing systems to be migrated
- Identify and gather third-party hardware support diskettes, adapter device drivers, and peripheral device drivers (if necessary)
- Determine overall installation sequence and strategy

Unit 3. Installing and Configuring OS/2 Warp Server for e-business

Objectives

After completing this unit, you should be able to:

- Update installation diskettes
- Install, remove and configure boot manager
- Install and format a bootable OS/2 Warp Server for e-business volume
- Install and configure server components
- Create and name new partitions
- Create, modify, and format volumes
- Configure the server to function in the context of the larger network
- Back up and print critical files
- Create emergency boot diskettes
- Install Lotus Domino
- Install IBM WebSphere
- Test the network installation and configuration
- Document the network installation and configuration

Server Packaging

Server

- 14 NLV packages

Server Upgrade

- 14 NLV packages

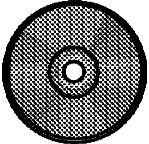
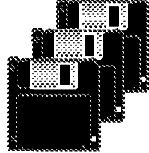
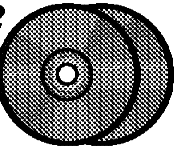
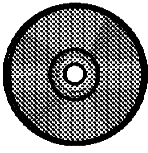
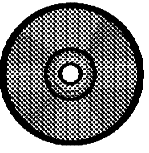
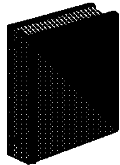
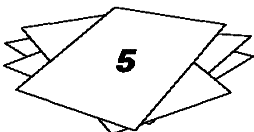
One Language	One Language	All Languages	One Language	14 Languages
<p>1 </p>	<p>3 </p>	<p>2 </p>	<p>1 </p>	<p>1 </p>
<p>Server:</p> <ul style="list-style-type: none"> › OS/2 base and File Systems › UNI and SMP Kernels › LAN Server › Neighborhood Browser Enabler › MPTS › TCP/IP and DHCP/DDNS › SSL 3.2 › LAN Adapter (Subset) › 40-bit Encryption › Printer Drivers (Subset) › Device Drivers (Subset) › REXX › PPP Server › PSnS Management › Tivoli Management Agent › Java Virtual Machine 1.1.7 › Netscape Communicator* › HPFS386 "Fix Pak" › ART Registration › Online Library 	<p>Boot Diskettes</p> <p>One Language</p> <p>1 </p>	<p>Client Connect Pak (OS/2 Warp 4, Windows 9X, Windows NT 4.0, and DOS/Windows 3.1 Clients)</p> <ul style="list-style-type: none"> › Tivoli Management Agent › Feature Install › Network Transport Services › TCP/IP and Dynamic Services › File/print services › Logon Client › Remote Access › HTML Browser* › Java runtime <p>See Client Connect Pak Matrix for details</p>	<p>Netfinity 5.2</p> <ul style="list-style-type: none"> › IBM WebSphere Application Server 1.1 › Lotus Domino Go Webserver 4.6.2.6 	<p>Ts and Cs</p> <p>5 </p>

Server Packaging

HPFS386 Feature

- 14 NLV packages

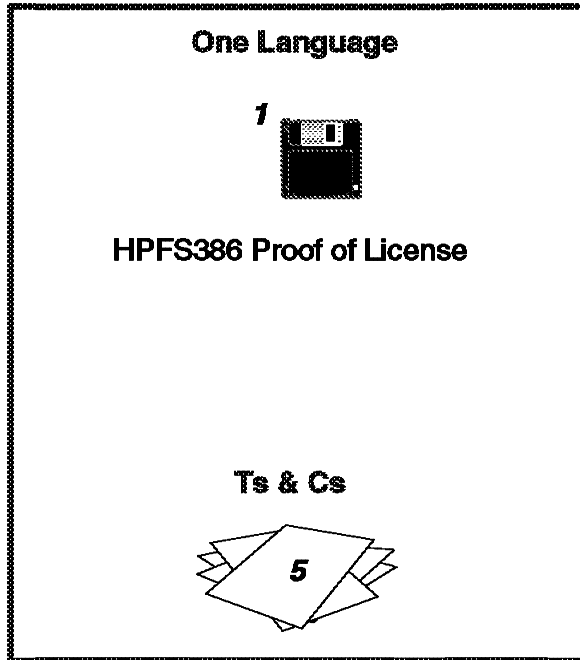

Security Feature

- Single package

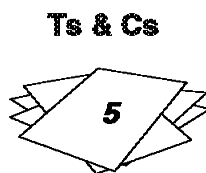
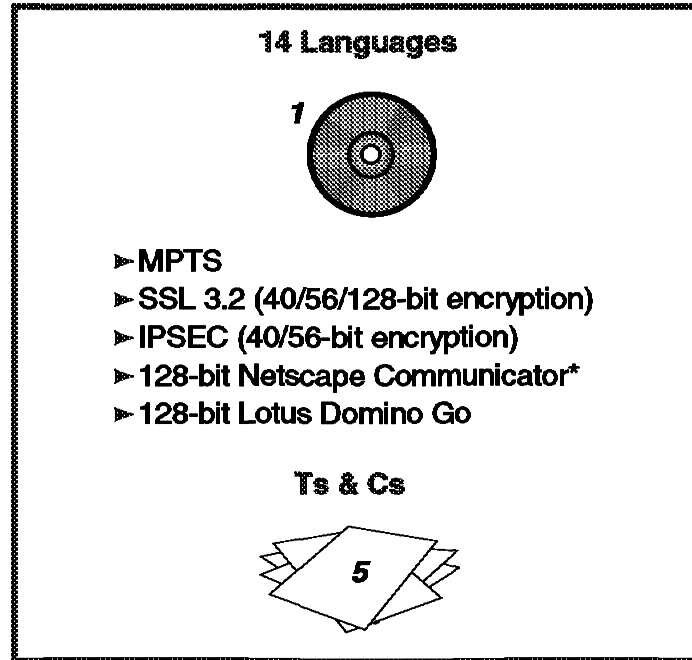

IPLA (16 languages)
License Information (16 languages)
Service and Support Statement (one language)
Server Proof of Entitlement (one language)
User Access Proof of Entitlement (one language)

Available on Internet

- DD Pak
- Printer Pak
- LAN Adapters
- Developer's Connection OS/2 Toolkit

Hard Disk Requirements

OS/2 Warp Base Operating System -- default installation	96.7 MB
OS/2 Warp Base Operating System -- with all components	156.0 MB
File and Print Sharing Services	15.0 MB
TCP/IP Services	30.0 MB
Remote Access Services	5.9 MB
Netscape Communicator	11.0 MB
Tivoli Management Agent	1.5 MB
Personally Safe 'n Sound (Backup and Restore)	7.2 MB
Lightweight Directory Access Protocol Toolkit	4.2 MB
Advanced Print Services	54.0 MB
Multiple Protocol Transport Services	16.0 MB
First Failure Support Technology	0.1 MB
Online Books	10.0 MB

ClientPak (2 CD-ROMs)

- **Client Connect Pak**
- **(OS/2 Warp 4, Windows 9X,**
- **Windows NT 4.0, and**
- **DOS/Windows 3.1 Clients)**
- **Tivoli Management Agent**
- **Feature Install**
- **Network Transport Services**
- **TCP/IP and Dynamic Services**
- **File/print services**
- **Logon Client**
- **Remote Access**
- **HTML Browser***
- **Java runtime**

Client Connect Pak Matrix

	OS/2 Warp 4	Windows 95	Windows NT 4.0	DOS/Win 3.1
System Management	Tivoli Agent CD 2	N/A	N/A	N/A
Feature Install	OS/2 Feature CD 1	N/A	N/A	N/A
Network Services	MPTS CD 1	Included in operating system	Included in operating system	LAN Support Program CD 2
IP Services	TCP/IP 4.2.1 CD 1	Dynamic IP Client CD 2	Dynamic IP Client CD 2	DOS LAN Services CD 2
File and Print Services	OS/2 File and Print Client CD 2	Included in operating system	Included in operating system	DOS LAN Services CD 2
Logon Services	OS/2 File and Print Client CD 2	Network Client for Windows 95 CD 2	Primary Logon Client CD 2	DOS LAN Services CD 2
Remote Access	LAN Distance CD 2	Included in operating system	Included in operating system	N/A
Browser	Netscape 4.04 CD 1	Included in operating system	Included in operating system	N/A
Java	Java Dev Toolkit CD 1	Java Dev. Toolkit CD 2	Included in operating system	N/A

Year 2000 and Euro

OS/2 Warp Server for e-business is fully enabled to support upcoming Year 2000 (Y2K) and euro currency transitions

Support for the euro sign as the currency symbol is available when you specify country information during the installation process

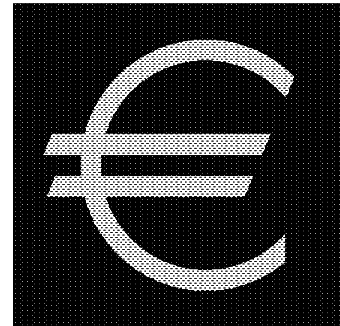
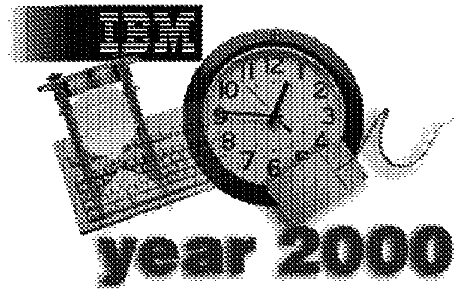

Java Support

Java 1.17 Shipped with OS/2 Warp Server for e-business

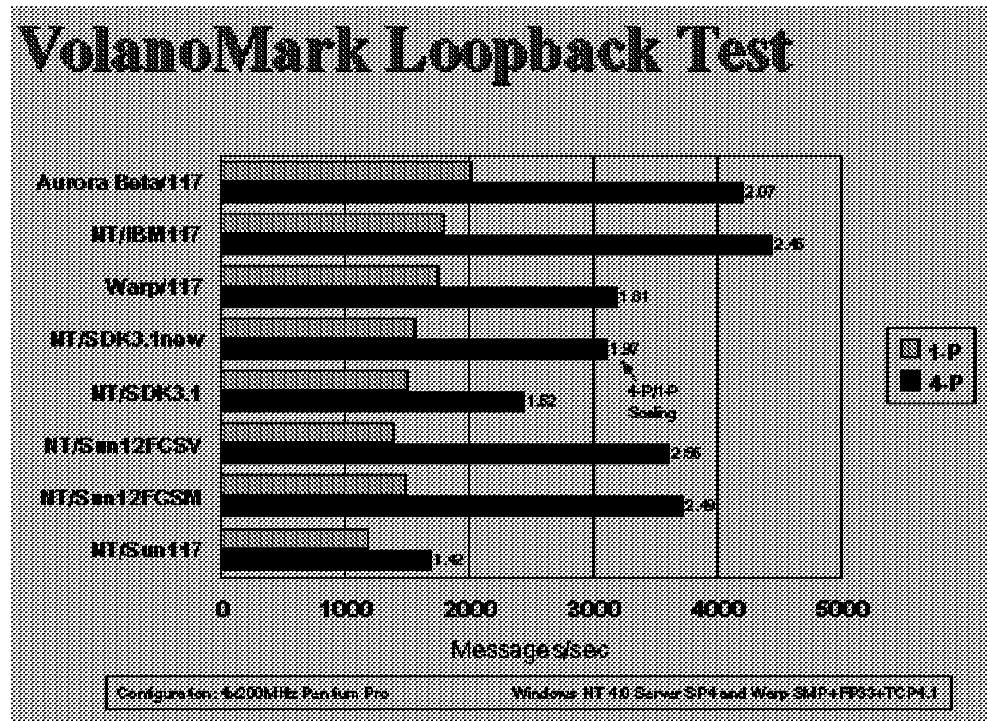

JFS Utilities

- Format
- Chkdsk
- Defrag
- Extend

LVM (Replaces fdisk)

- Create a partition
- Delete a partition
- Bootable volumes
- Non-bootable volumes
- Changing a drive letter assigned to a volume
- Expanding a volume
- Set or change a volume name
- Delete a volume
- Hide a volume from OS/2
- Unhide a volume from OS/2



Refer to Chapter 3 of the *Network Administrator's Guide* and Chapter 5 of *Quick Beginnings: Installing OS/2 Warp Server for e-business*

System Configuration (1 of 2)





System Configuration

If the following hardware and country choices are correct, select Next. To change a choice, select the icon beside it.





Locate

 Country United States	 Keyboard United States
--	---

System

 Mouse PS/2 (tm) Style Pointing Device	 Primary Display SVGA (Cirrus Logic)
 Serial Device Support Support Installed	 Secondary Display None

Currently Installed Peripherals

 CD-ROM Device Support Toshiba 5302B,5602B	 Printer No printers attached
 Multimedia Device Support None	 SCSI Adapter Support None

Next **Help**

System Configuration (2 of 2)

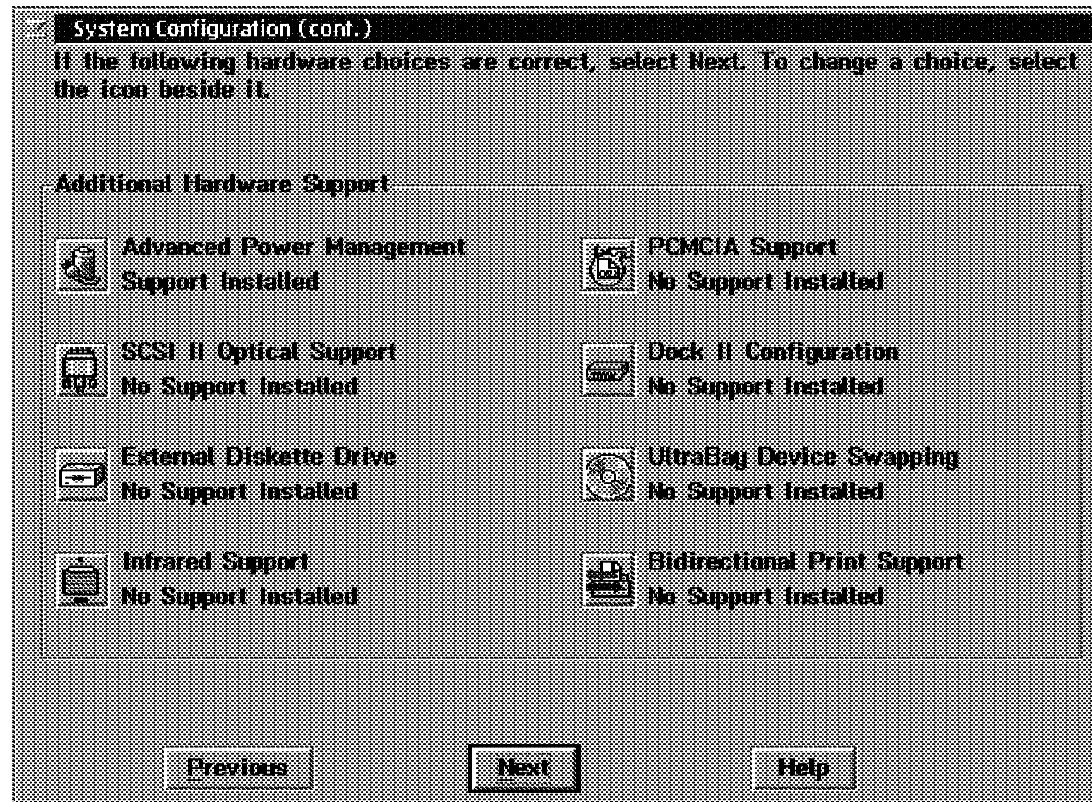

Default Printer

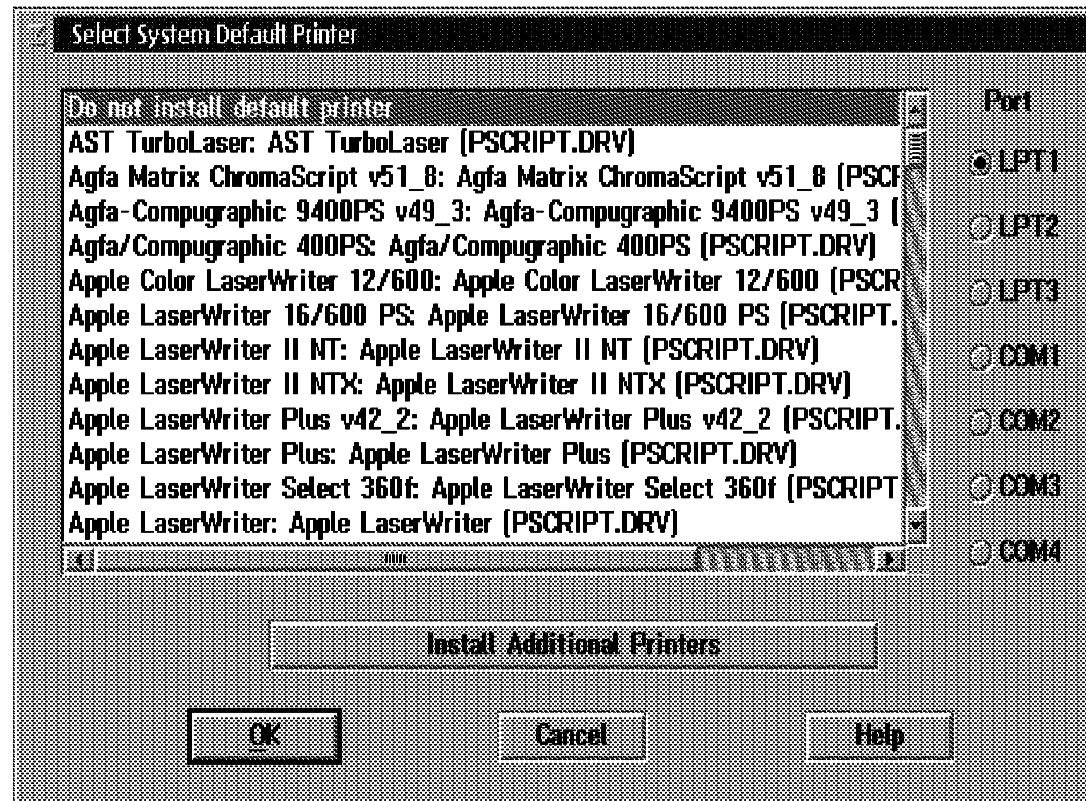

Primary Display Drivers

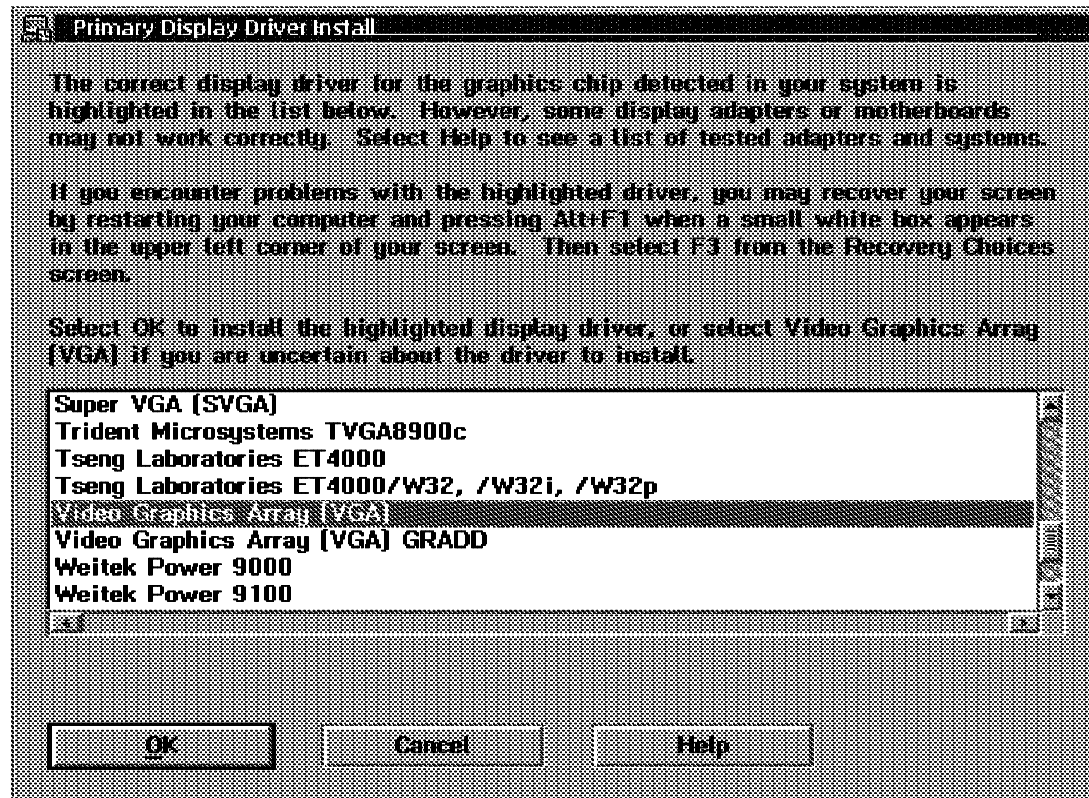

Setup and Installation (1 of 2)

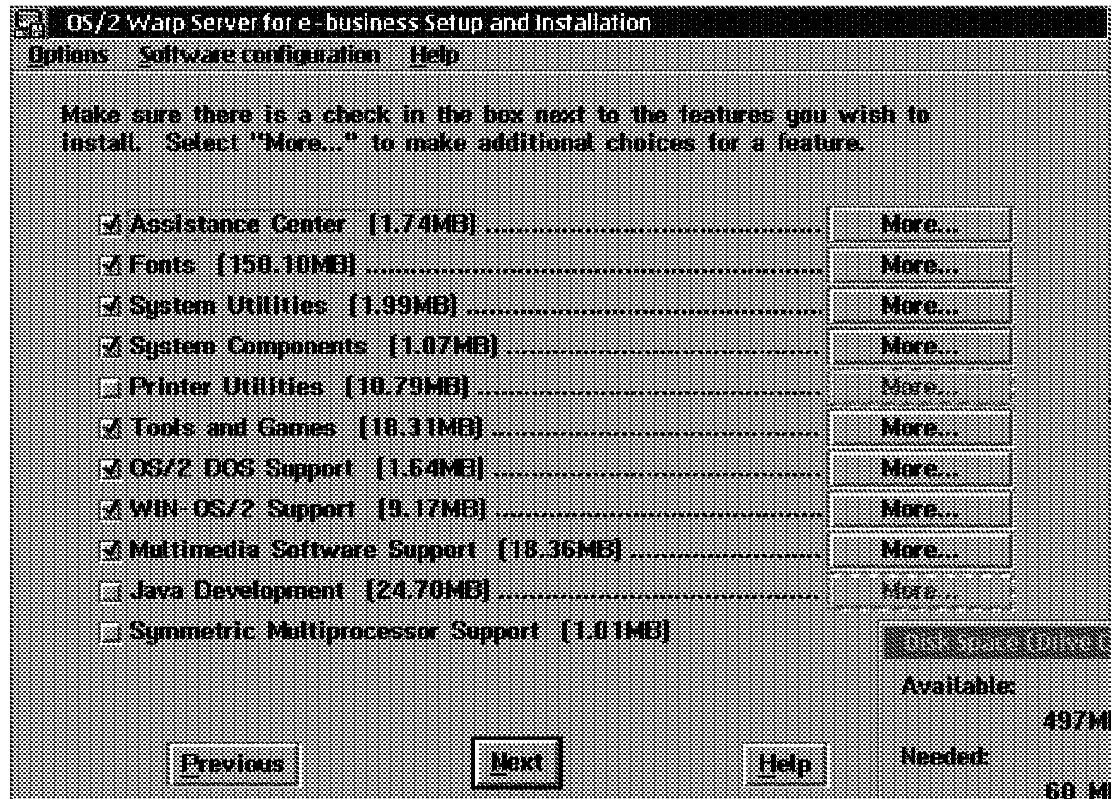

Setup and Installation (2 of 2)

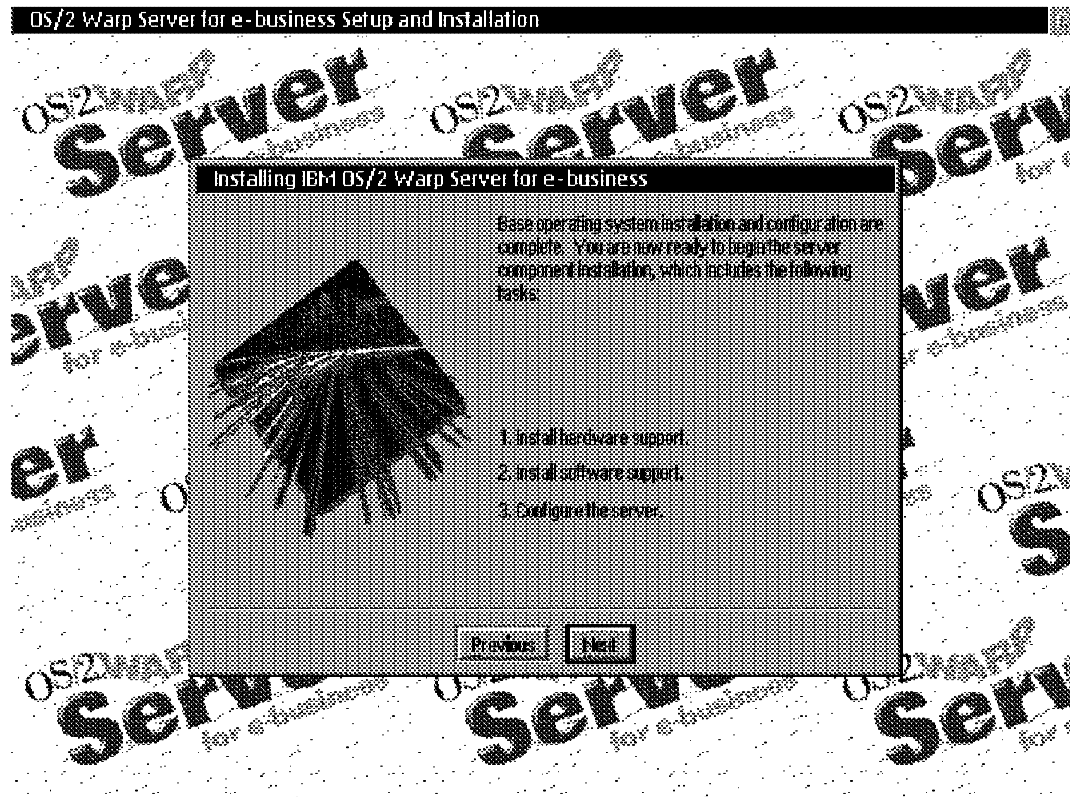

Setup and Installation - Information

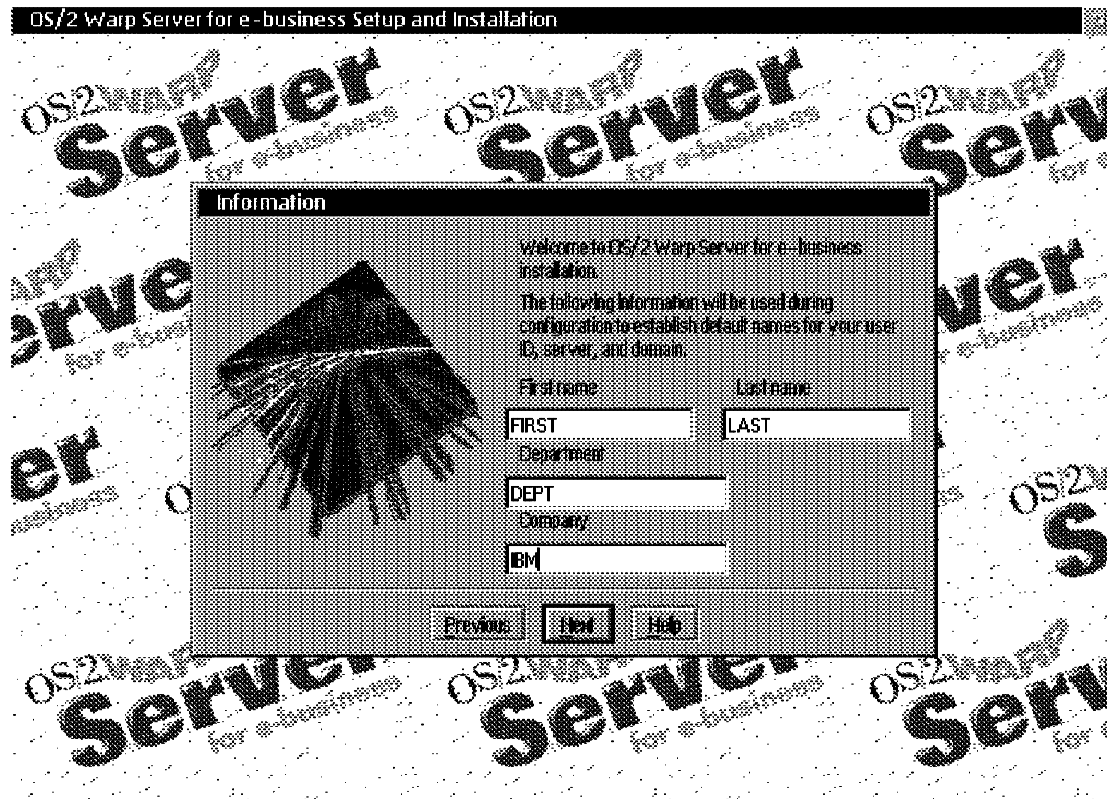

Select Services

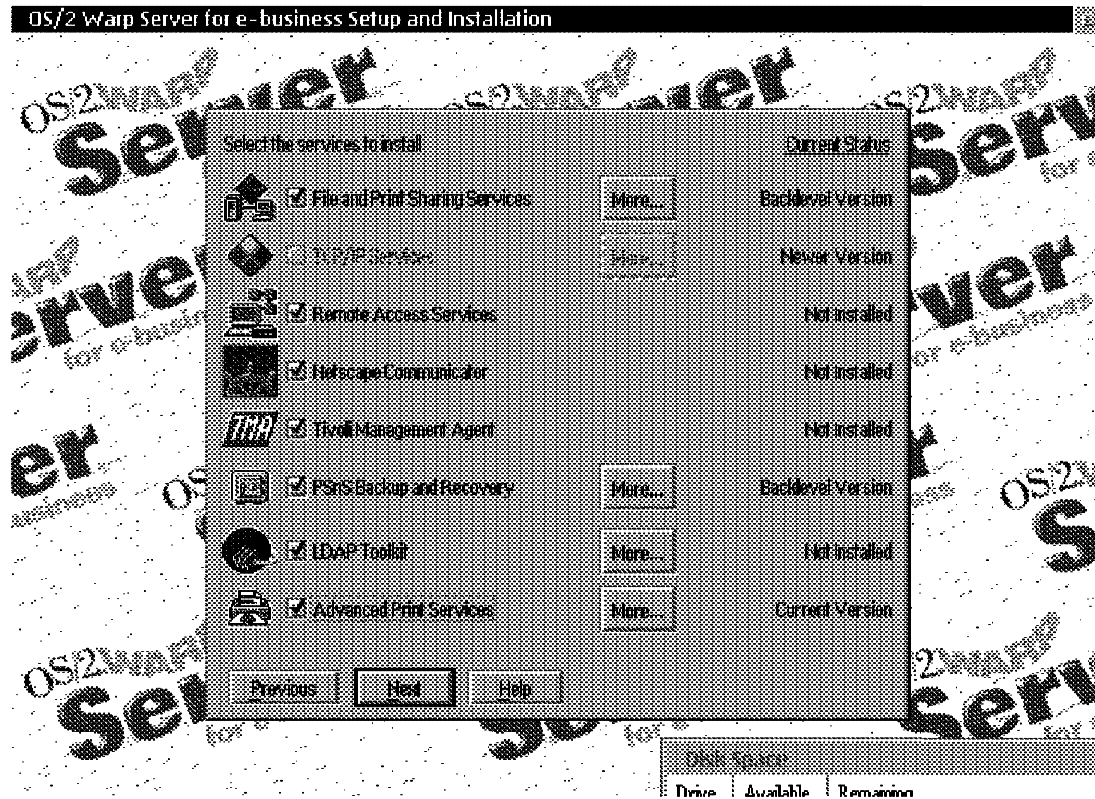

File and Print

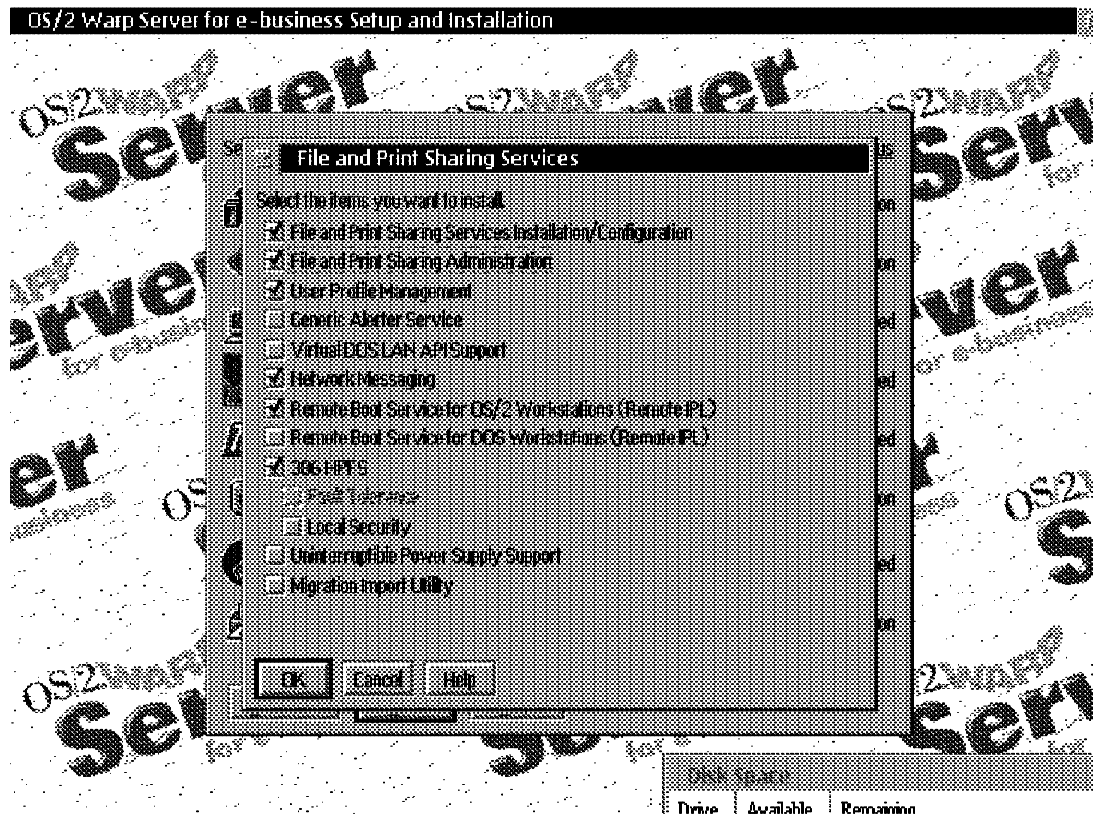

Configuration

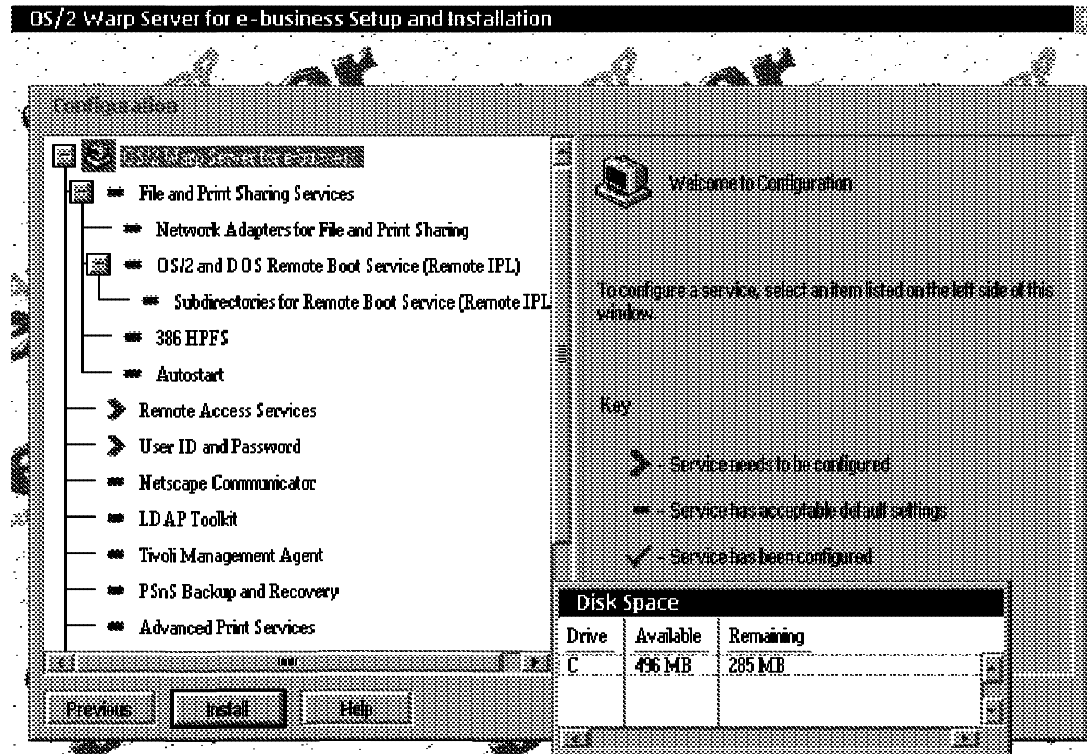

File and Print

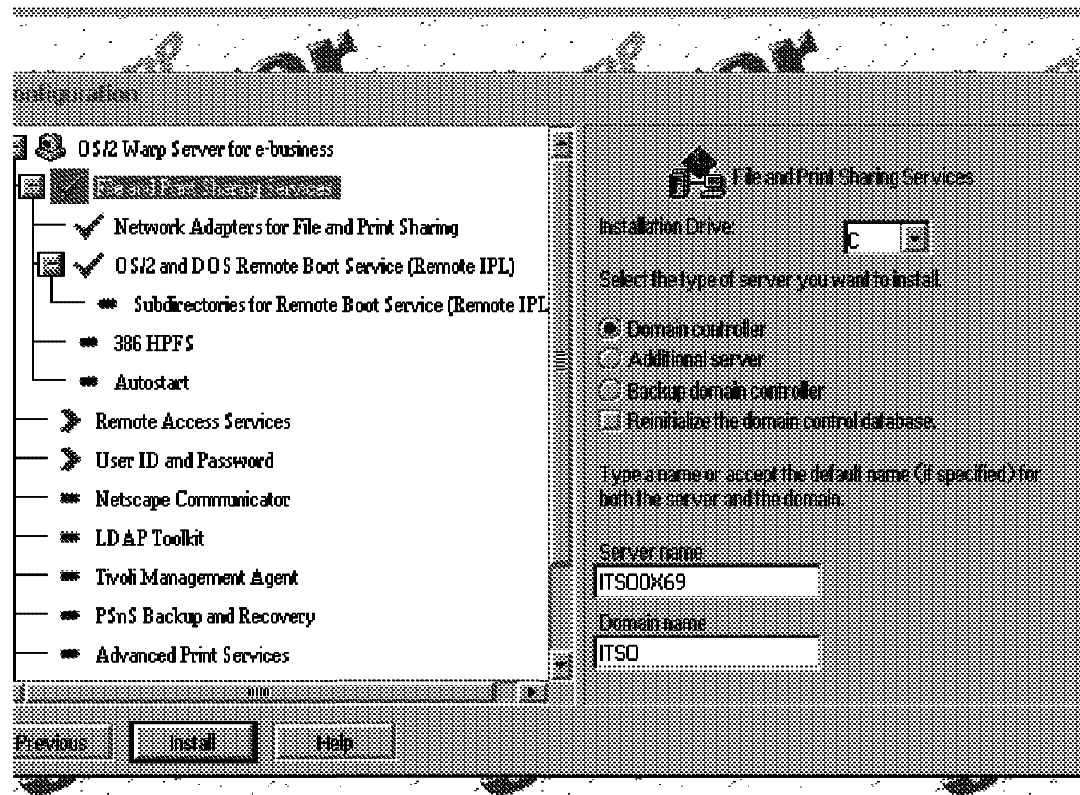

Network Adapters

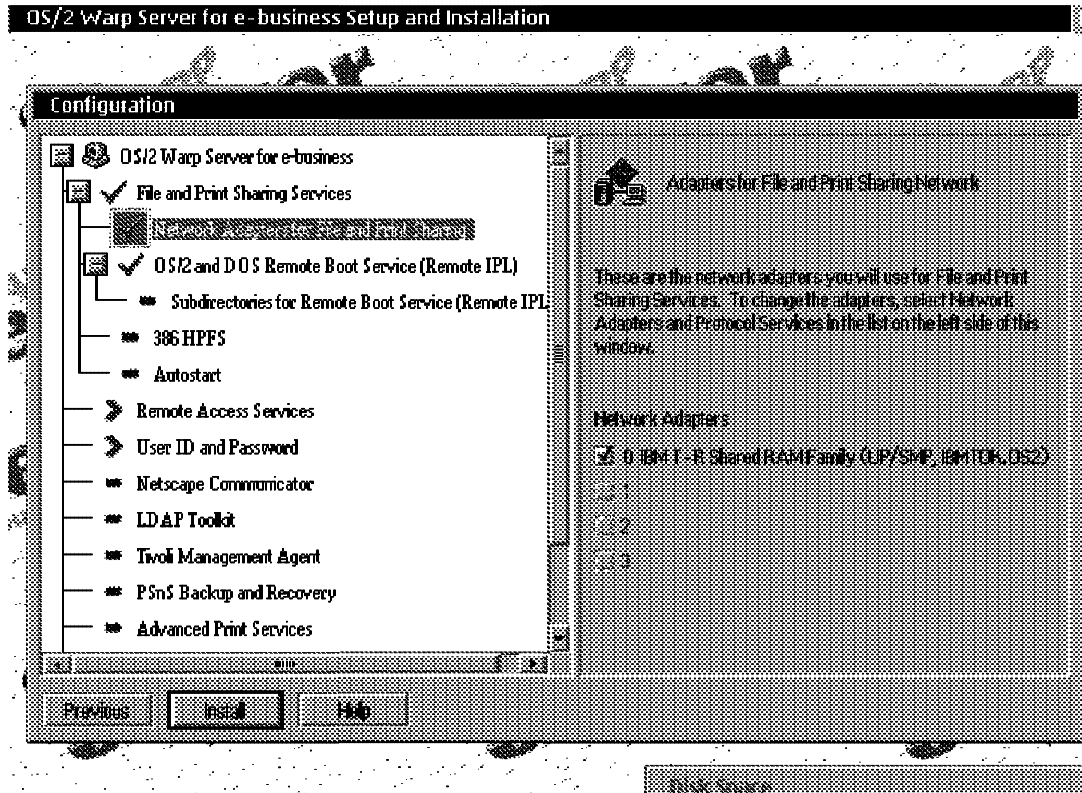

Remote IPL (1 of 2)

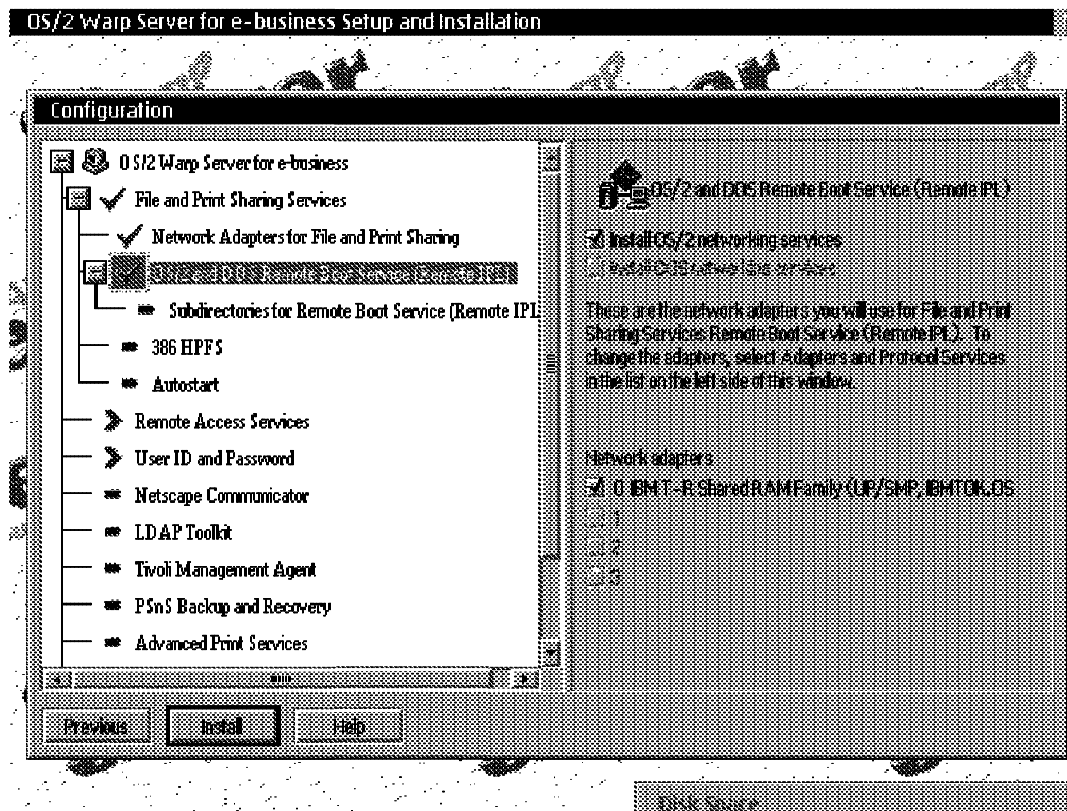

Remote IPL (2 of 2)

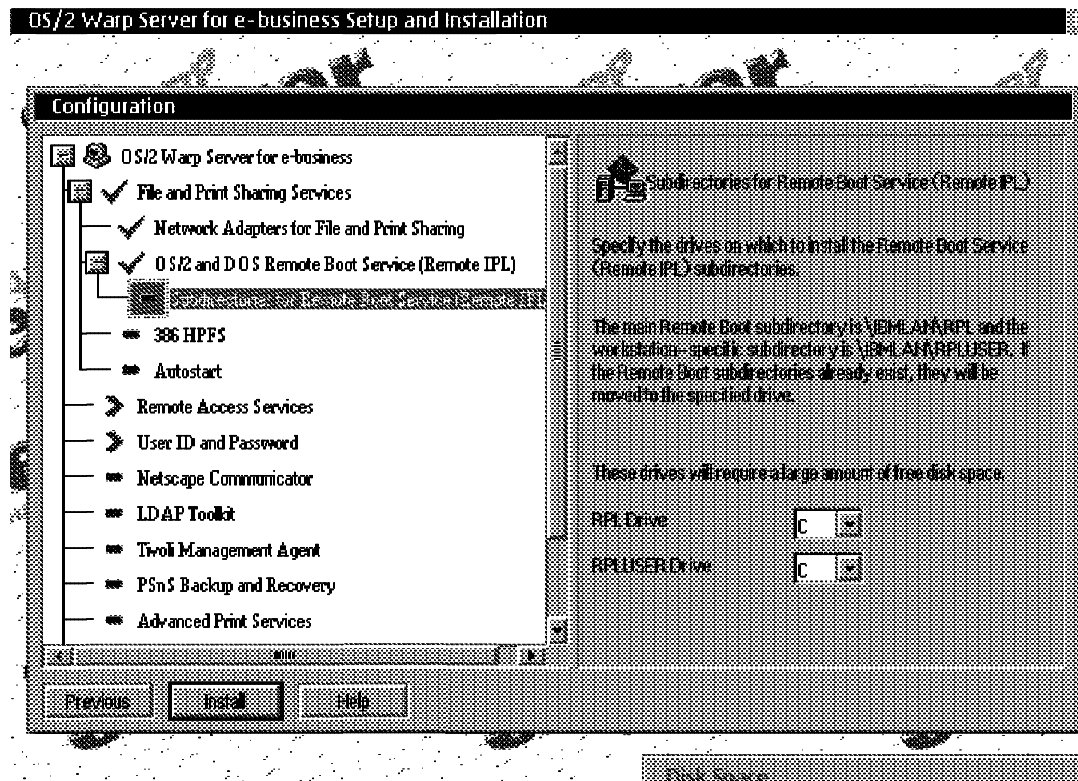

386HPFS

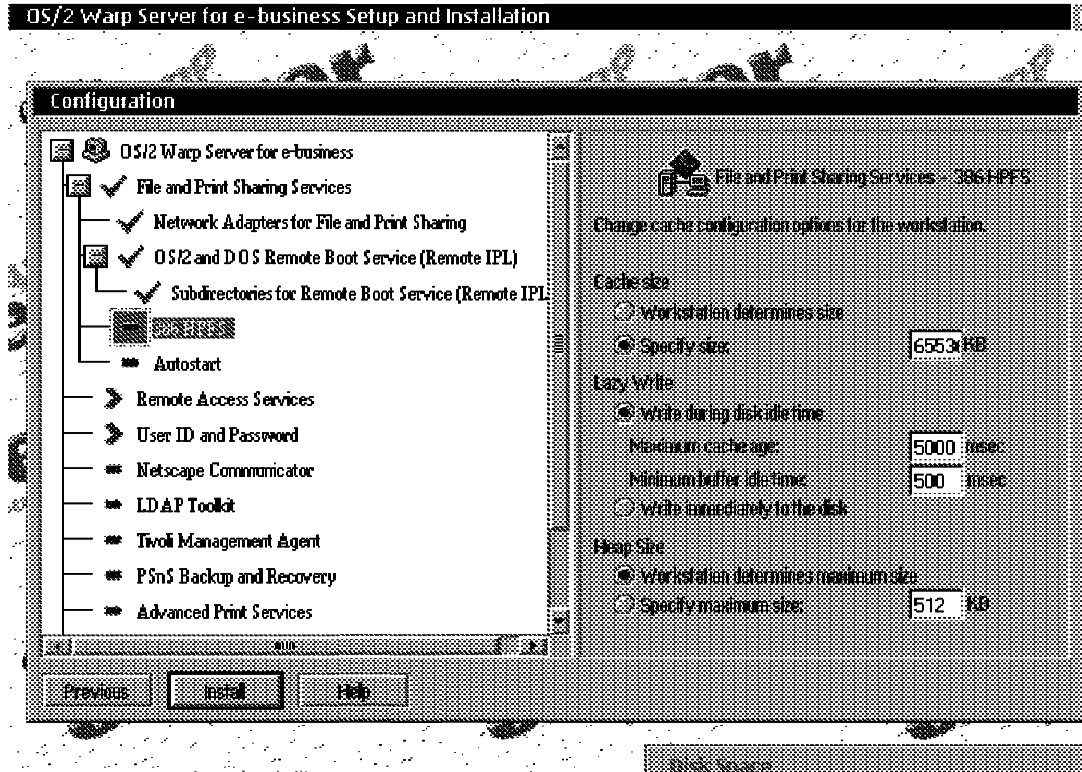

Autostart

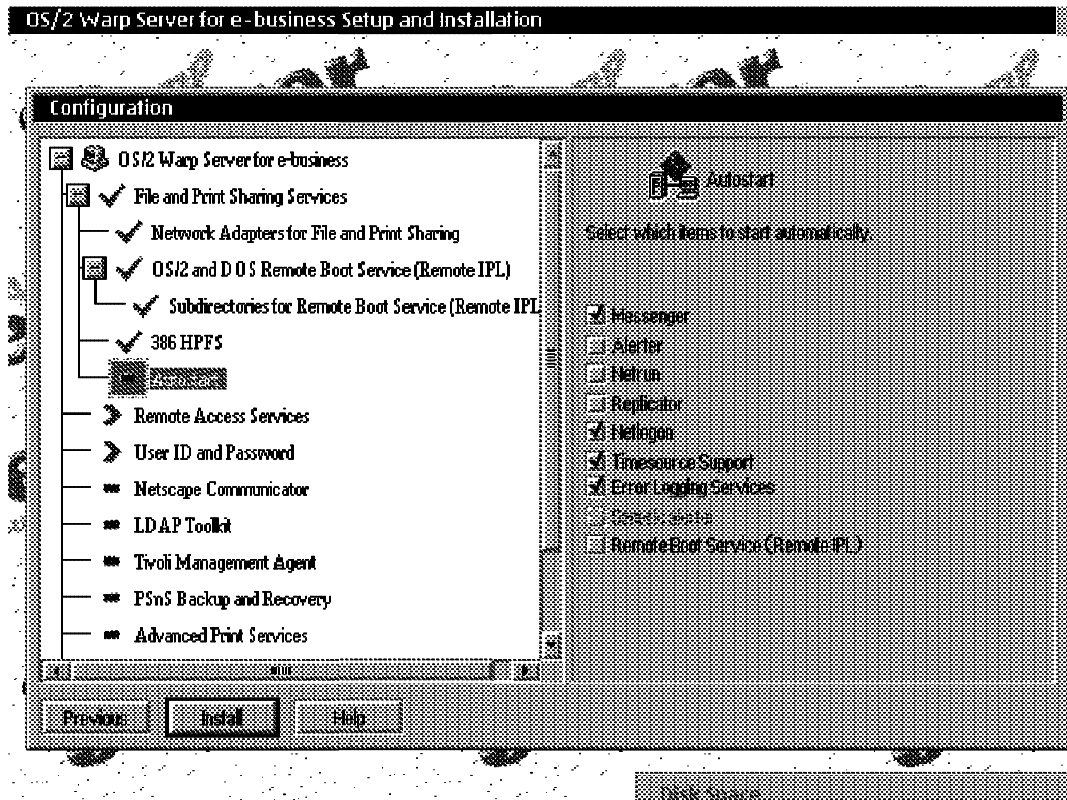

Remote Access Services

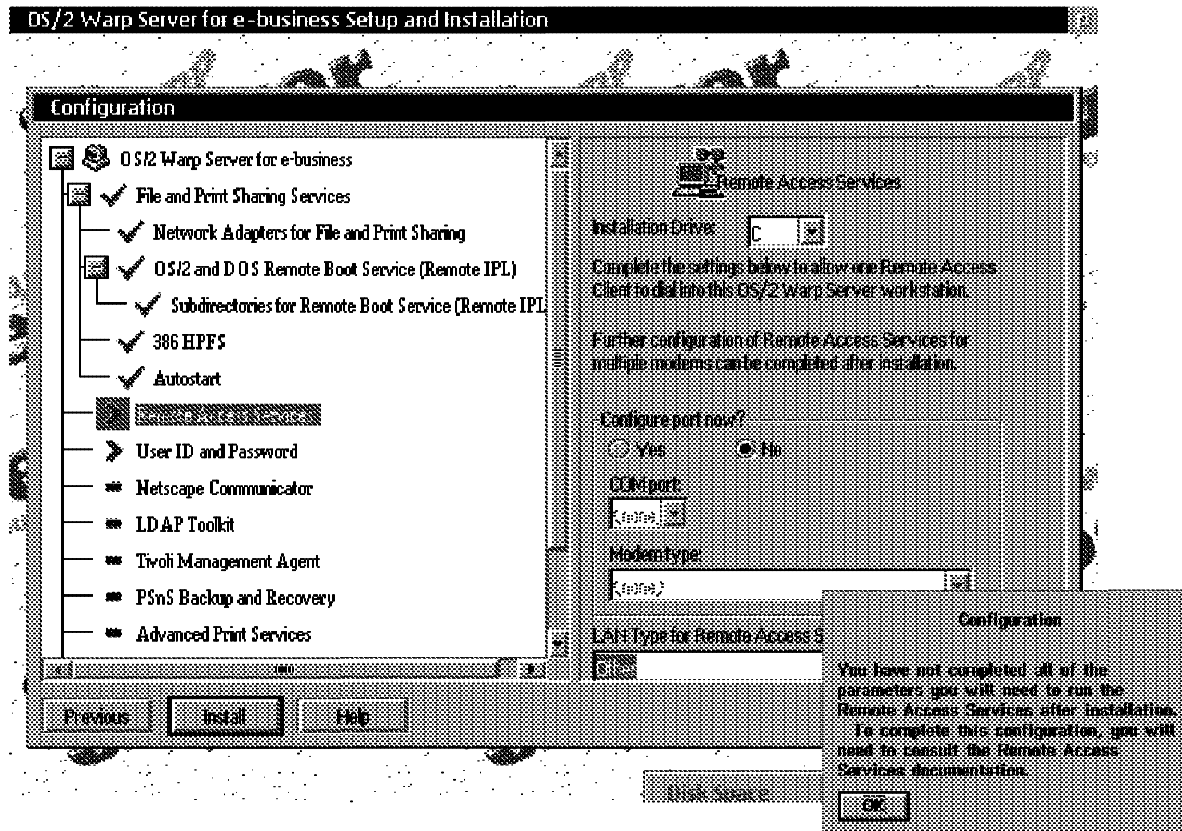

Administrator ID / Password

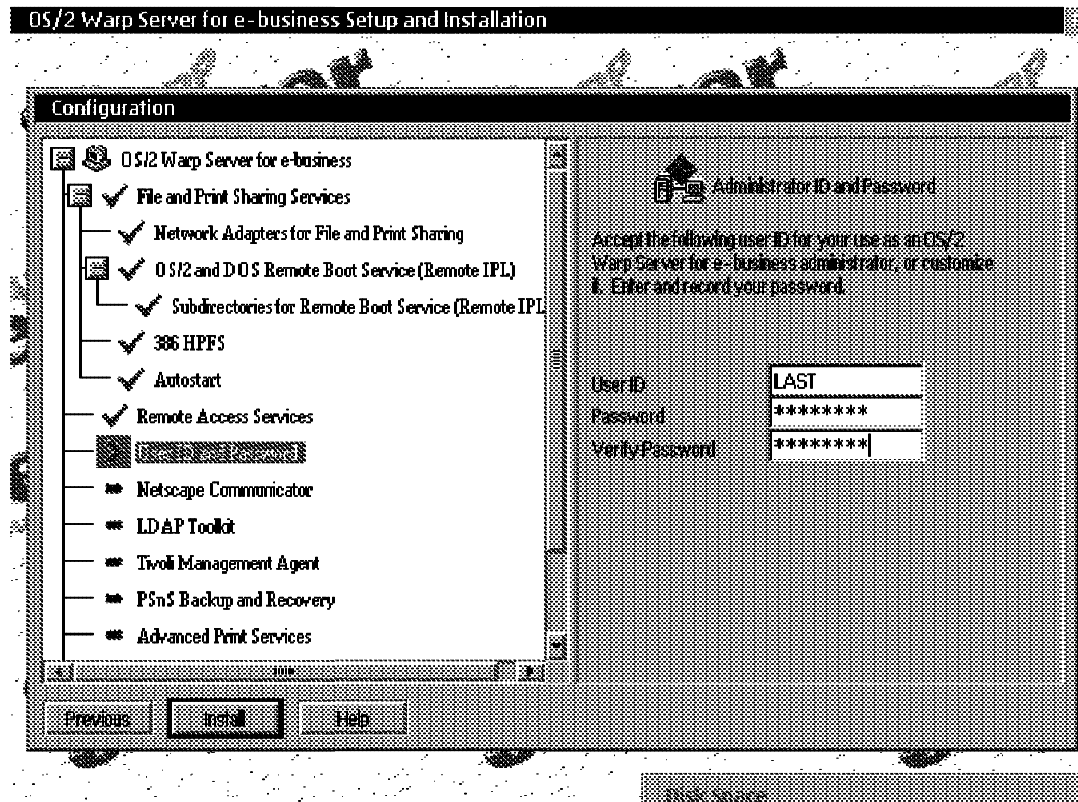

TCP/IP Services

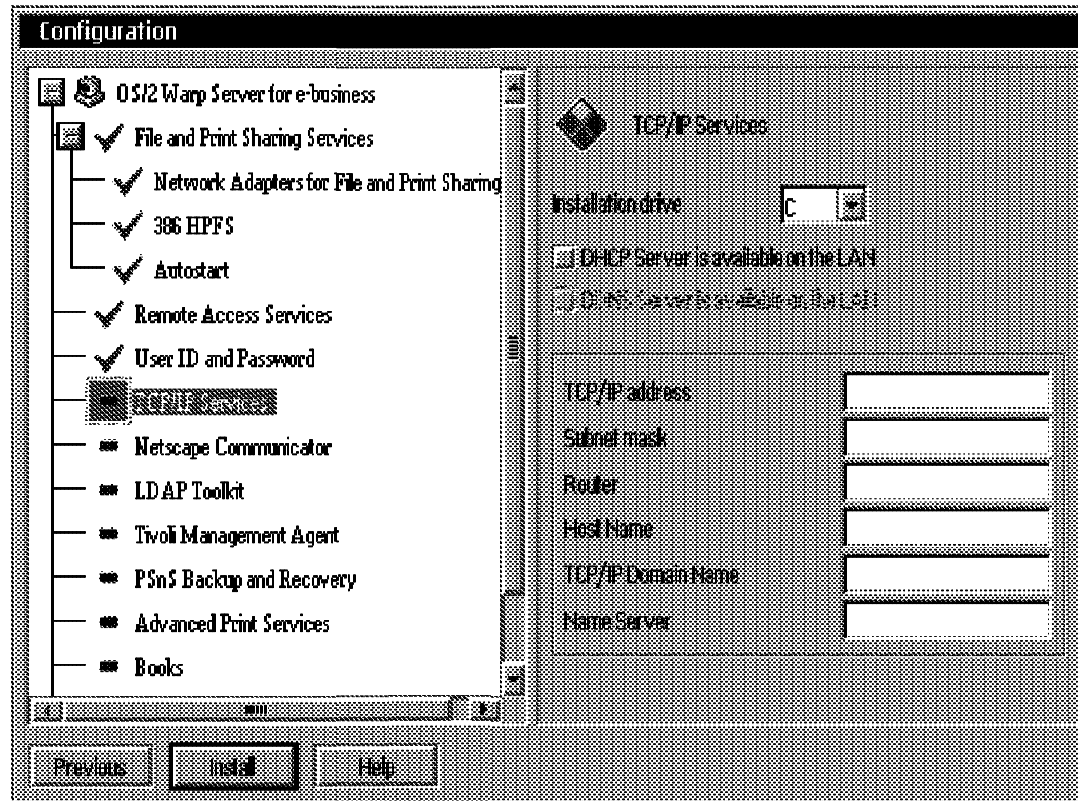

Netscape Communicator

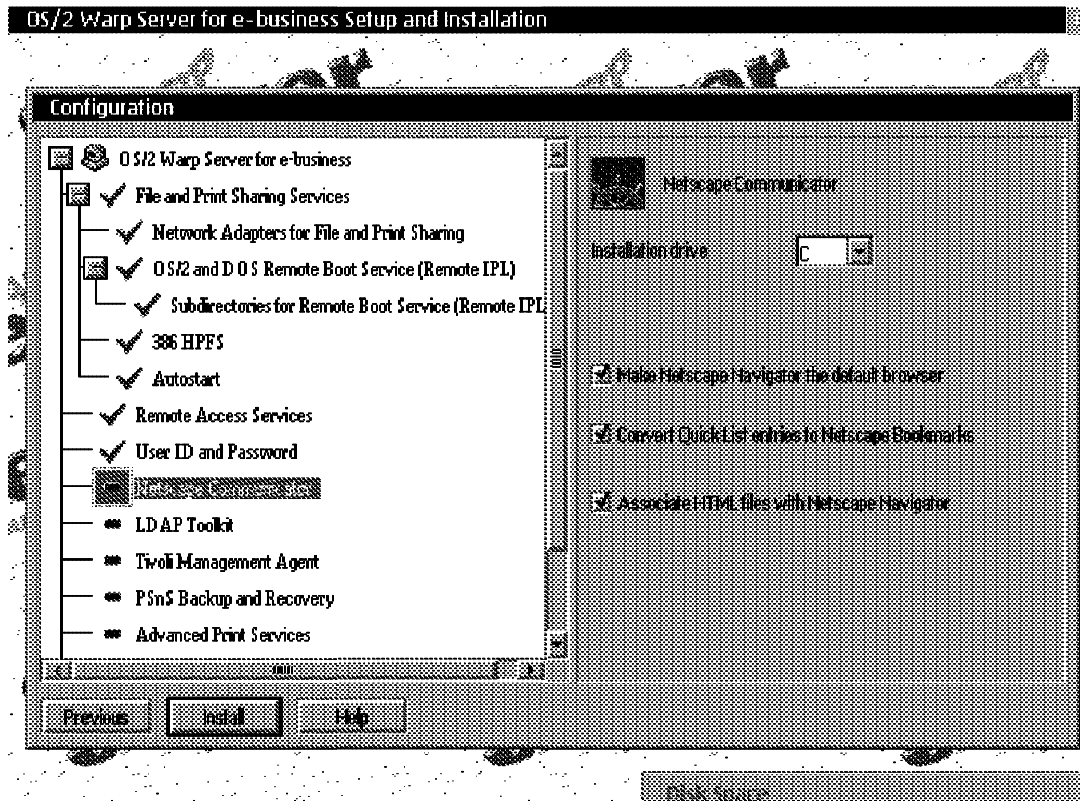

LDAP Toolkit

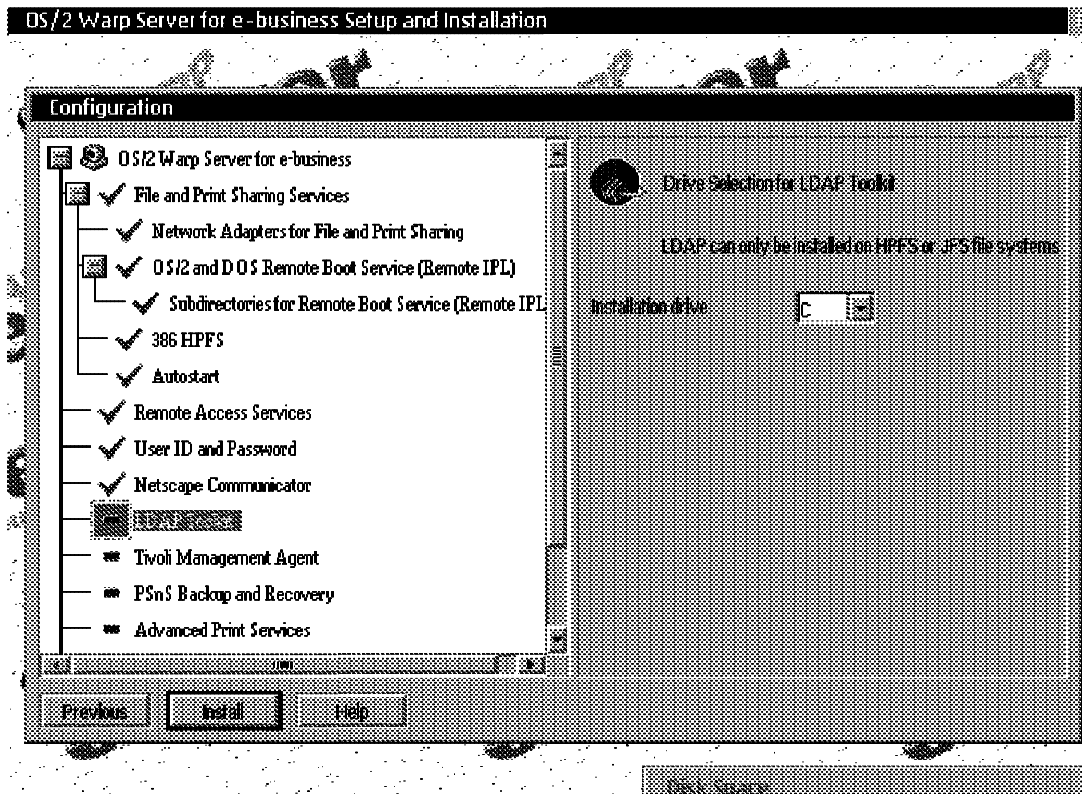

Tivoli Management Agent

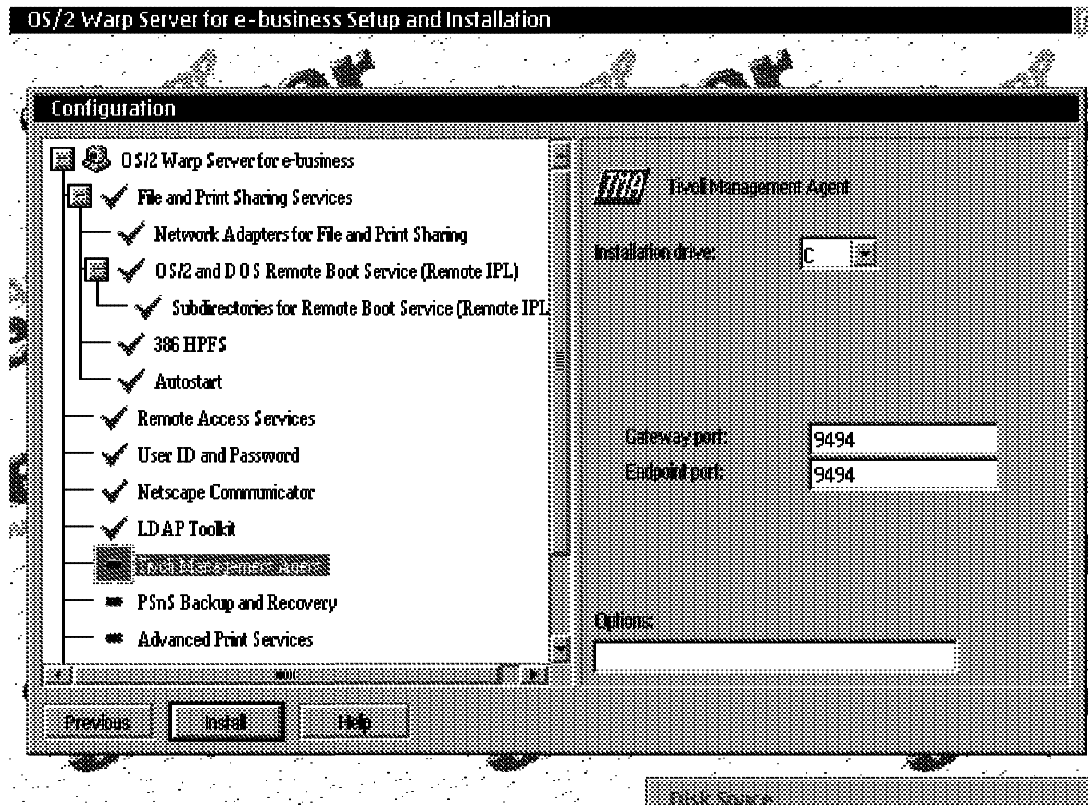

Backup and Recovery (PSnS)

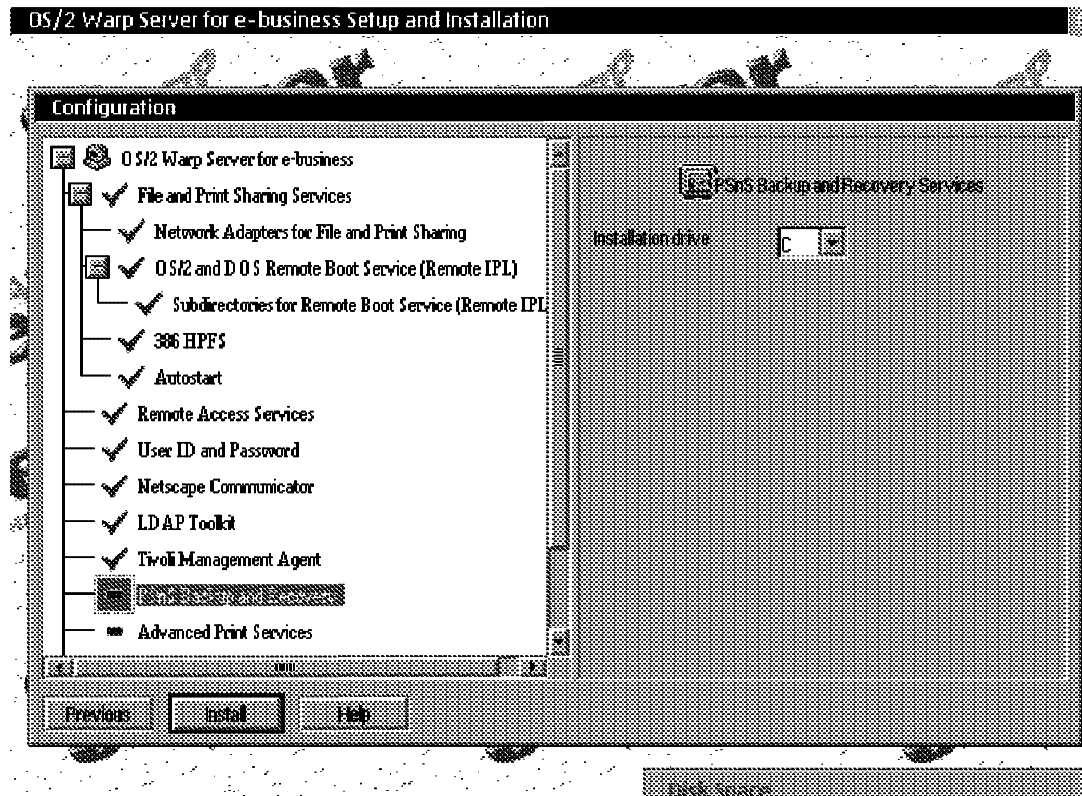

Advanced Print Services

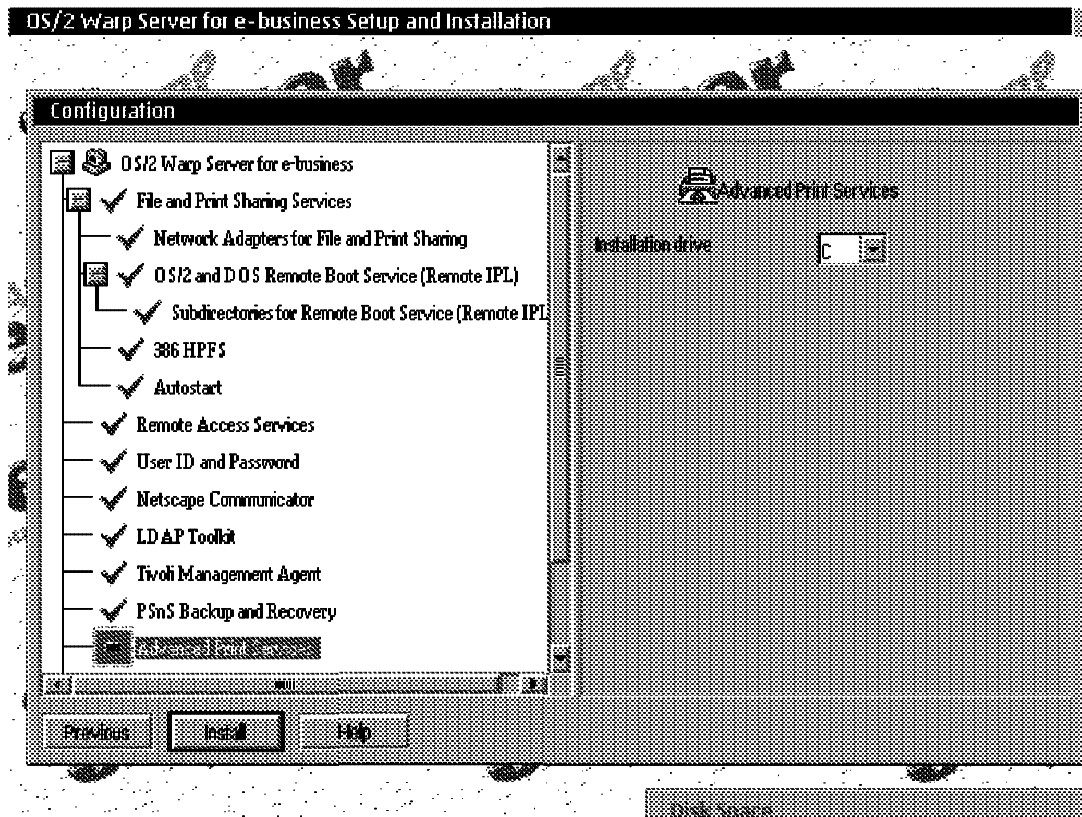

Books

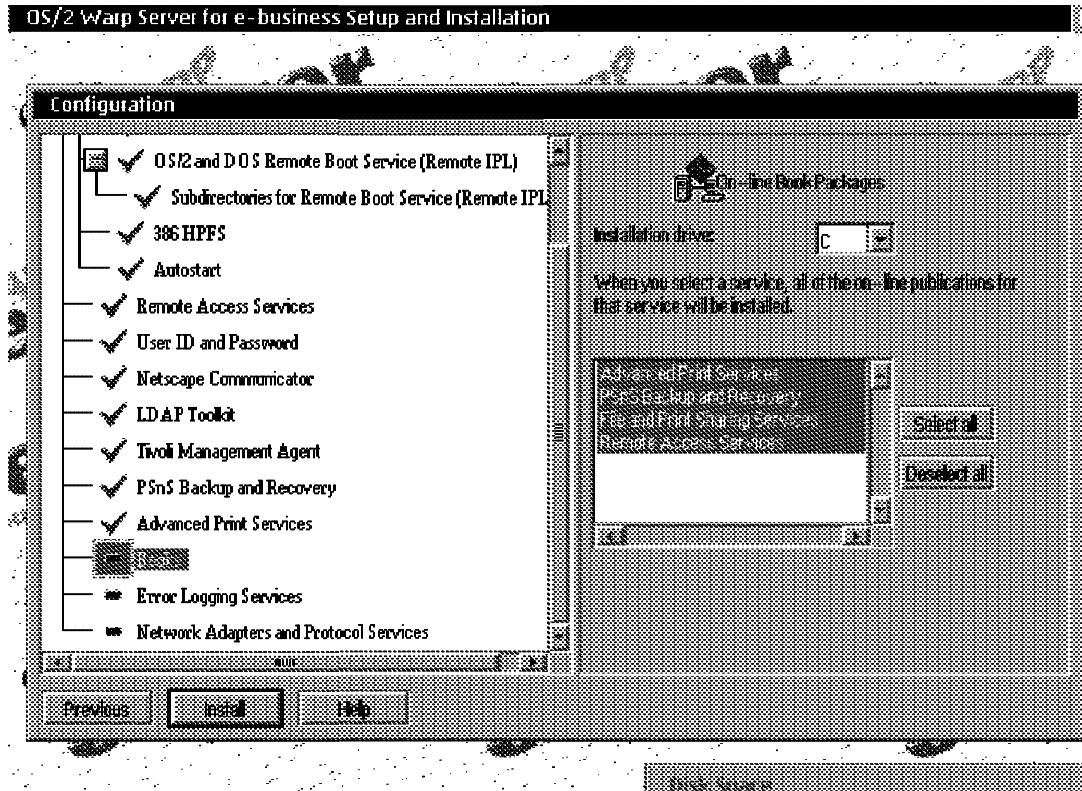

Error Logging

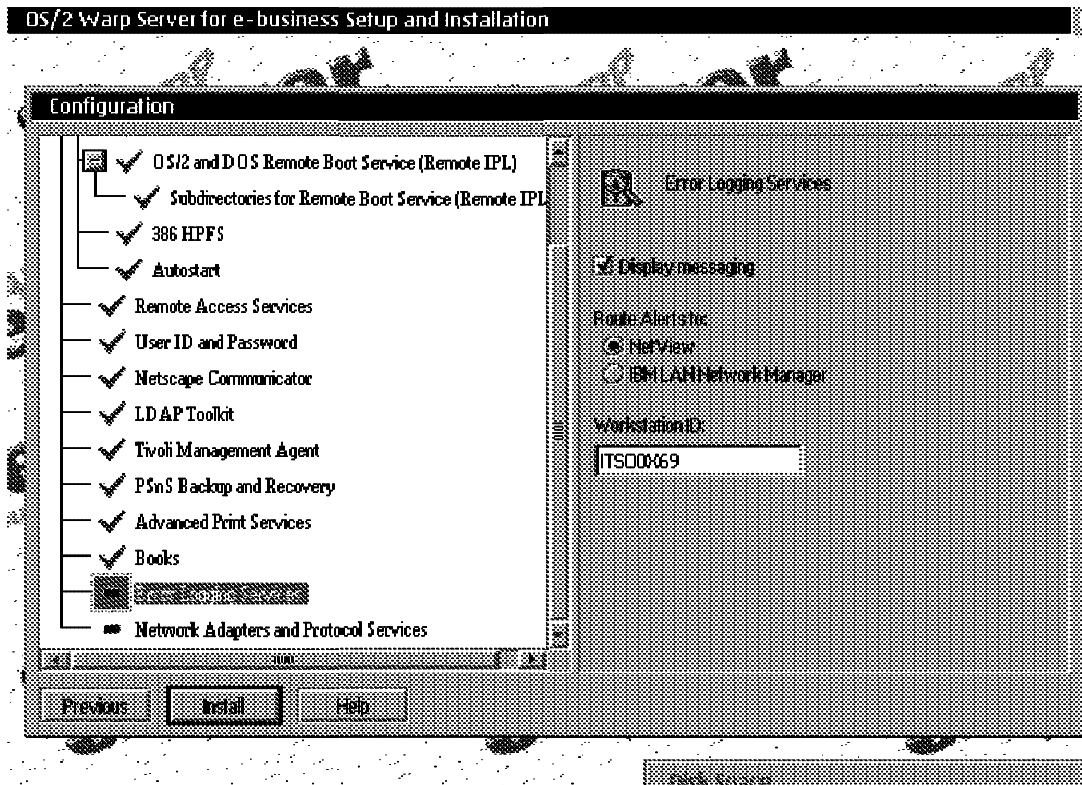

Adapter and Protocol Services

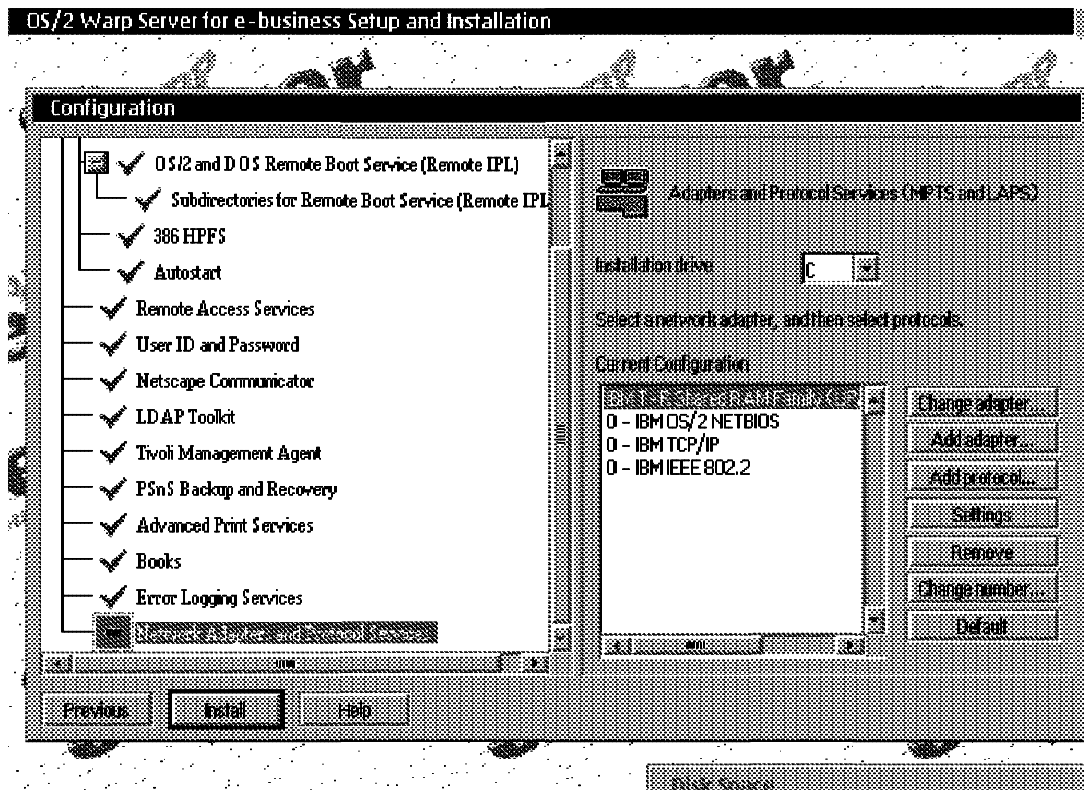

Configuration Complete



Tuning Assistant

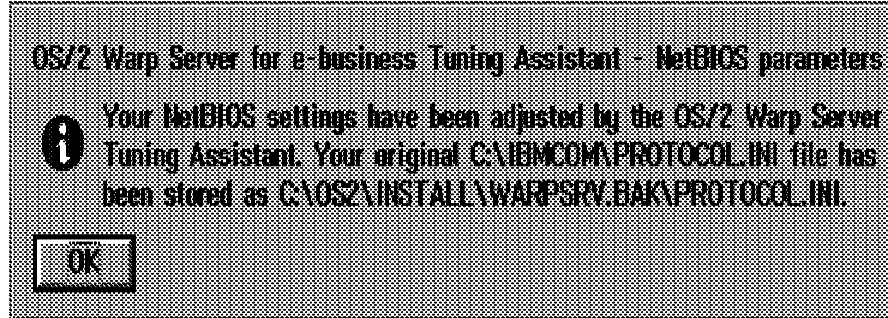

Installing Additional Components

- **MPTS Strong Encryption**
 - Security features CD 1
 - SSL IPSEC Libraries
 - 56/128 bit encryption
- **Lotus Domino Go Webserver**
 - Security features CD 2
 - Install before Websphere
- **IBM WebSphere**
 - Security features CD 2
 - Uninstall Go Java Servlet Component
 - Update Java 1.1.7

Unsupported Tools

- MPTS Applets (\CID\SERVER\MPTS\UTILITY\APPLETS)
 - NBJDSTAT
 - DTF7
 - MCL
 - SNIFFLE
 - NETPING
 - LAPSDUMP
 - MAPNAME
 - OS2SNIFF
 - NB64K
 - NETTRACE

Productivity Aids (\CID\SERVER\IBMLS\IBM500P1)

- **SMBTOOL**
- **ACM**
- **QMC**
- **RDRDEBUG**
- **FINDNAME**
- **SNAPDF**
- **SNAPDUMP**
- **NCBSTAT**
- **NETSESS2**

Back up Critical Files



Emergency Boot Disk



Unit Summary

You should now be able to:

- Update installation diskettes
- Install, remove and configure boot manager
- Install and format a bootable OS/2 Warp Server for e-business volume
- Install and configure server components
- Create and name new partitions
- Create, modify, and format volumes
- Configure the server to function in the context of the larger network
- Back up and print critical files
- Create emergency boot diskettes
- Install Lotus Domino
- Install IBM WebSphere
- Test the network installation and configuration
- Document the network installation and configuration

Unit 4. Administering Common Tasks in OS/2 Warp Server for e-business

Objectives

After completing this unit, you should be able to:

- Perform initial network administration tasks checklist
- Start, stop, and pause server services
- Access the network from various systems
- Manage domains
- Define and share network resources
- Create and apply access control profiles
- Manage network printing
- Define and manage users and groups
- Manage and add volumes and partitions
- Implement backup and recovery
- Manage network security
- Create and manage server applications

Initial Network Administration Tasks

- Create spooler queues and printers on the servers
- Start the domain controller, logon to the DC, and define additional servers
- Disable and re-enable user logon (optional)
- Define shared resources (directories, printers, and serial devices)
- Define access control profiles for the resources
- Create public applications definitions to be shared on the network
- Define users and groups
- Assign resources to be made available to users during logon
- Plan to backup the domain controller database (DCDB) regularly
- Print/save the domain definition

Managing Network Services

- **Alerter**
- **DCDB Replicator**
- **Generic Alerter**
- **LSserver**
- **Messenger**
- **NetLogon**
- **Netrun**
- **Network Neighborhood Browser Enabler**
- **Peer**
- **Remote IPL**
- **client**
- **Server**
- **Timesource**
- **UPS**

Network Service Status

The text below shows network service status types.

Status	Meaning
Started and Active	The service is running normally
Not started	The service has not been started
Started and paused	The service has been stopped temporarily
Started with pause pending	The service is about to pause
Started with continue pending	The service is about to continue after being paused
Stopping	The service is about to stop
Starting	The service is about to start

Guidelines for Stopping and Pausing Network Services

Keep the following in mind when stopping and pausing network services:

- When the Messenger service is stopped on a workstation, that workstation can no longer receive messages or alerts.
- When the Requester service is stopped on a server, the server and OS/2 Warp Server or LAN server program also stops. Users lose access to that server's network resources. If any user is logged on at that server, stopping the Requester service logs them off. After the Server service stops on a server, that workstation can function only as a client and can no longer share resources with users.
- Pausing a client temporarily disables use of shared resources, but you are not disconnected from those resources. If you pause a server, no new requests to use the resources at that server are accepted. However, pausing a server does not affect files that are currently open or outstanding requests to use resources.

Stopping and Pausing a Network Service

- NetLogon
- Netrun
- Peer
- Requester
- Server

Command Line Access

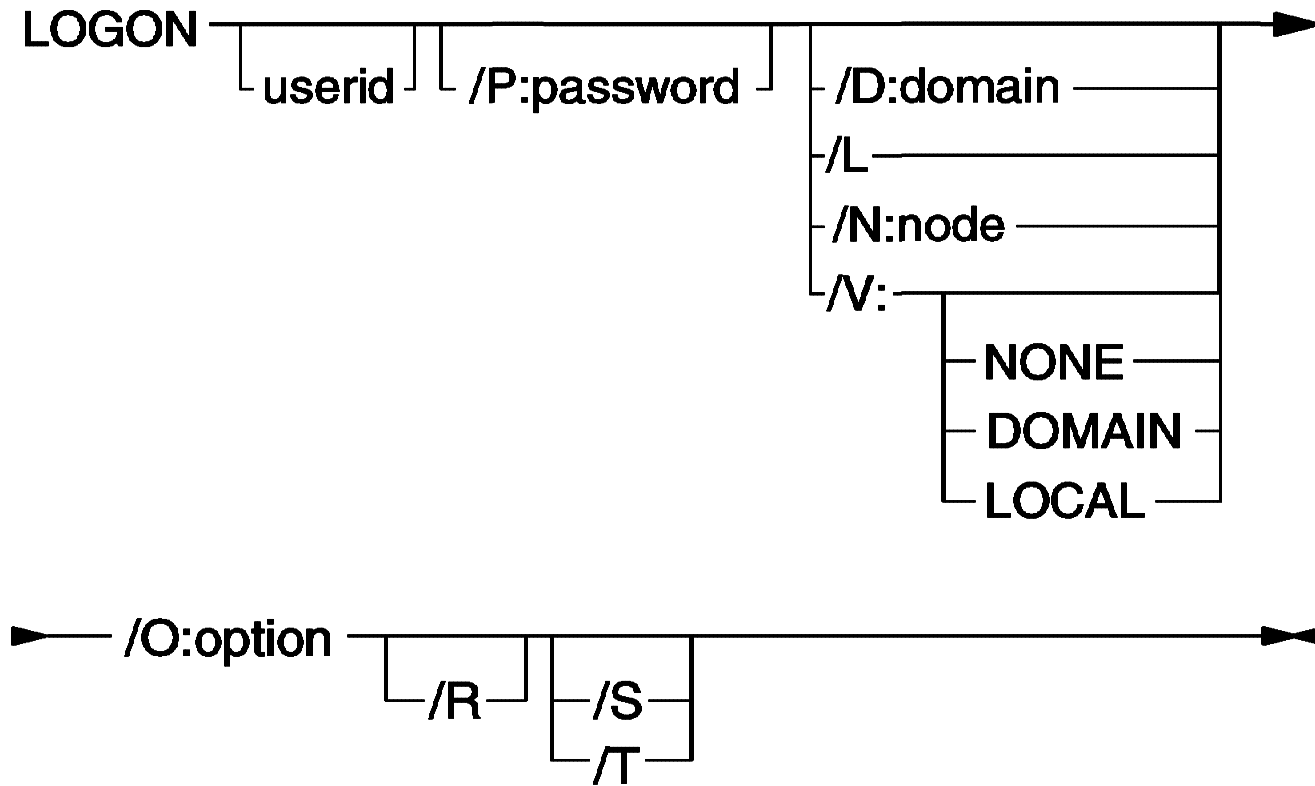

LAN Logon (1 of 2)

LAN Logon

Note: The password will not display.

Verification: Domain

User ID DENIS

Password

Domain name CANADA

OK Cancel Help

LAN Logon (2 of 2)

- User account defined on the other domain
 - Password should be identical
- Access permissions on the other domain
- othdomains =

Setup the Domain

- Installation on all servers
- Administrator logon
- Define Additional servers
- Start Backup Domain Controllers
- Start Additional servers
- Disable User logons
 - NET PAUSE NetLogon
- Define users and groups
- Define shared resources
- Define access control profiles
- Install and define public applications
- Configure Remote IPL
- Assign logon assignments
- Plan to back up the domain controller database
- Enable User logon
 - NET CONTINUE NetLogon
- Print/save the Domain Controller Database

Refer to Chapter 2 of the *Network Administrator's Guide*

USERS

- Features
 - Up to 16,000 users per domain
 - User and group ID cloning
 - Drag and drop enablement
 - Home directories for users
 - Directory limits on users
- Managed through NET.ACC
- Changes propagated to additional servers
- UPM (local)
- Restricted names
 - ADMINS
 - GROUPID
 - GUESTS
 - LOCAL
 - PUBLIC
 - RPLGROUP
 - SERVERS
 - SYSASID
 - USERS
 - IBM ???
 - SQL???
 - SYS???
- Logon assignments
- Public applications
- Privileged operators

GROUPS

- 247 group IDs per domain (256-9 reserved)
- Restricted names
 - USERS
 - ADMINS
 - GROUPID
 - SERVERS
 - LOCAL
 - GUESTS
 - RPLGROUP
 - SYSASID
 - PUBLIC

Refer to Chapter 5 of the *Network Administrator's Guide*

Access Control Profile

- Independent of alias or netname
- File, Directory, Root
- Propagation
- User or Group (64 max)
 - None (N)
 - Delete (D)
 - Attributes (A)
 - Execute (X)
 - Read (R)
 - Write (W)
 - Create (C)
 - Permissions (P)

Access Permissions Applicable to Resource Types

Access permission	Files	Printers	Serial Devices	Named Pipes
None (N)	X	X	X	X
Execute (X)	X			
Read (R)	X		X	X
Write (W)	X		X	X
Create (C)	X	X	X	X
Delete (D)	X			
Attributes (A)	X			
Permissions (P)	X	X	X	X

Refer to - Chapter 7 of the *Network Administrator's Guide*

Types of Resources

- **Directory Resources**
 - Directory or subdirectory on a server containing programs or data files that can be made available to users.
- **Spooler Queues (Printers)**
 - An ordered list of print jobs waiting to access a printer. A printer pool is a group of printers servicing a single spooler queue.
- **Serial Device Queues**
 - Serial devices, such as plotters, com ports, modems
- **Drives**
 - Logical drive that contains a root directory and subdirectories
 - Sharing a drive resource allows LAN users to connect to all data and applications on that drive.
- **Resources Other Domains**
 - Any of the above. Previously called External Resources

Sharing Network Resources

- Sharing using netnames
 - Unique name per server (UNC)
 - \\server1\netname\path
 - Not portable
- Sharing using aliases
 - Unique per domain
 - Portable
 - Required for
 - Public applications
 - Logon assignments

Directory Limits (386 HPFS)

- **Terms**
 - Available space
 - Drive/Volume
 - Limit
 - Threshold alert
 - Threshold delay
 - Usage count
- **Hierarchical**
 - Directories only
 - Affects subdirectories
 - Users only

Refer to Chapter 6 of the *Network Administrator's Guide*

Network Printing

- Printer objects are printer queues
- Network folder to manage network printers
- Print Operator Privilege
- Client and servers must have same level of drivers
- Printer settings
 - Network job view
 - Refresh interval
 - Separator file
 - Start time
 - Stop time

Refer to Chapter 11 of the *Network Administrator's Guide*

Logical Volume Management Tool - Logical View

Logical Volume	Type	Status	File System	Size (MB)
Win95/NT/Warp 5	Compatibility		HPFS-H	1004
Warp 5	C: Compatibility	Bootable	HPFS	502
Warp 4	D: Compatibility	Bootable	HPFS	502
E drive	E: Compatibility		HPFS	2458
MiniBoot	F: Compatibility	Bootable	FAT16	302
Data	G: Compatibility		HPFS	8002
VCDROM	H: Compatibility		FAT16	701
Data 3	I: Compatibility		HPFS	4902
→ LVM	J: LVM		JFS	2005
[CBSIFS 1]	*->P: Compatibility		CBSIFS	0
Disk Partition	Size (MB)	Disk Name		
[P 0]	1002	Disk 2 - 8 GB		
[P 1]	1003	Disk 2 - 8 GB		

Physical Disk View

The screenshot displays the Logical Volume Manager interface for physical disk management. It shows two disks: Disk 3 (14GB, 13481 MB) and Disk 2 (8GB, 7811 MB). Disk 3 is divided into three partitions: a 1004 MB partition with file system G, a 2458 MB partition with file system JFS, and a 6002 MB partition with file system G. Disk 2 is divided into three partitions, each 1002 MB, all with file system JFS. Below the disk information is a table summarizing the logical volumes.

Volume Name	Partition Name	Status	File System	Size(MB)	Type
LVM	[P 0]		JFS	1002	Logical
LVM	[P 1]		JFS	1003	Logical

Install Boot Manager

The screenshot shows the 'Logical Volume Manager - Physical Disk View' window. The 'Boot Manager' menu is open, displaying the following options:

- Install Boot Manager
- Set/change Boot Manager options
- Add volume to Boot Manager
- Remove volume from Boot Manager
- Remove Boot Manager
- Set Boot Manager active

The background shows a graphical representation of the physical disk with partitions of various sizes and file systems (JFS, Other, Unformatted, Free Space).

Volume Name	Partition Name	Status	File System	Size(MB)	Type
LVM	[P 0]		JFS	1002	Logical
LVM	[P 1]		JFS	1003	Logical

Create Volume

The screenshot shows the 'Logical Volume Manager - Physical Disk View' window. The 'Volume' menu is open, displaying the following options:

- Create volume
- Set/change drive letter assigned to a volume
- Expand volume
- Set/change name on volume
- Delete volume
- Hide volume from OS/2
- Set volume startable

The background shows a disk layout with two physical disks (Dis 134 and Dis 781) and their corresponding logical volumes. The table below summarizes the visible data:

Volume Name	Partition Name	Status	File System	Size(MB)	Type
LVM	[P 0]		JFS	1002	Logical
LVM	[P 1]		JFS	1003	Logical

Create Partition

The screenshot shows the Logical Volume Manager - Physical Disk View interface. A context menu is open over a partition on Disk 3 (14GB total, 13461 MB used). The menu options are: Create partition, Change partition name, and Delete partition. The partition being targeted is 1002 MB in size and is currently JFS.

Volume Name	Partition Name	Status	File System	Size(MB)	Type
LVM	[P 0]		JFS	1002	Logical
LVM	[P 1]		JFS	1003	Logical

Commit Changes

Volume Name	Partition Name	Status	File System	Size(MB)	Type
LVM	[P 0]		JFS	1002	Logical
LVM	[P 1]		JFS	1003	Logical

LVM Overview

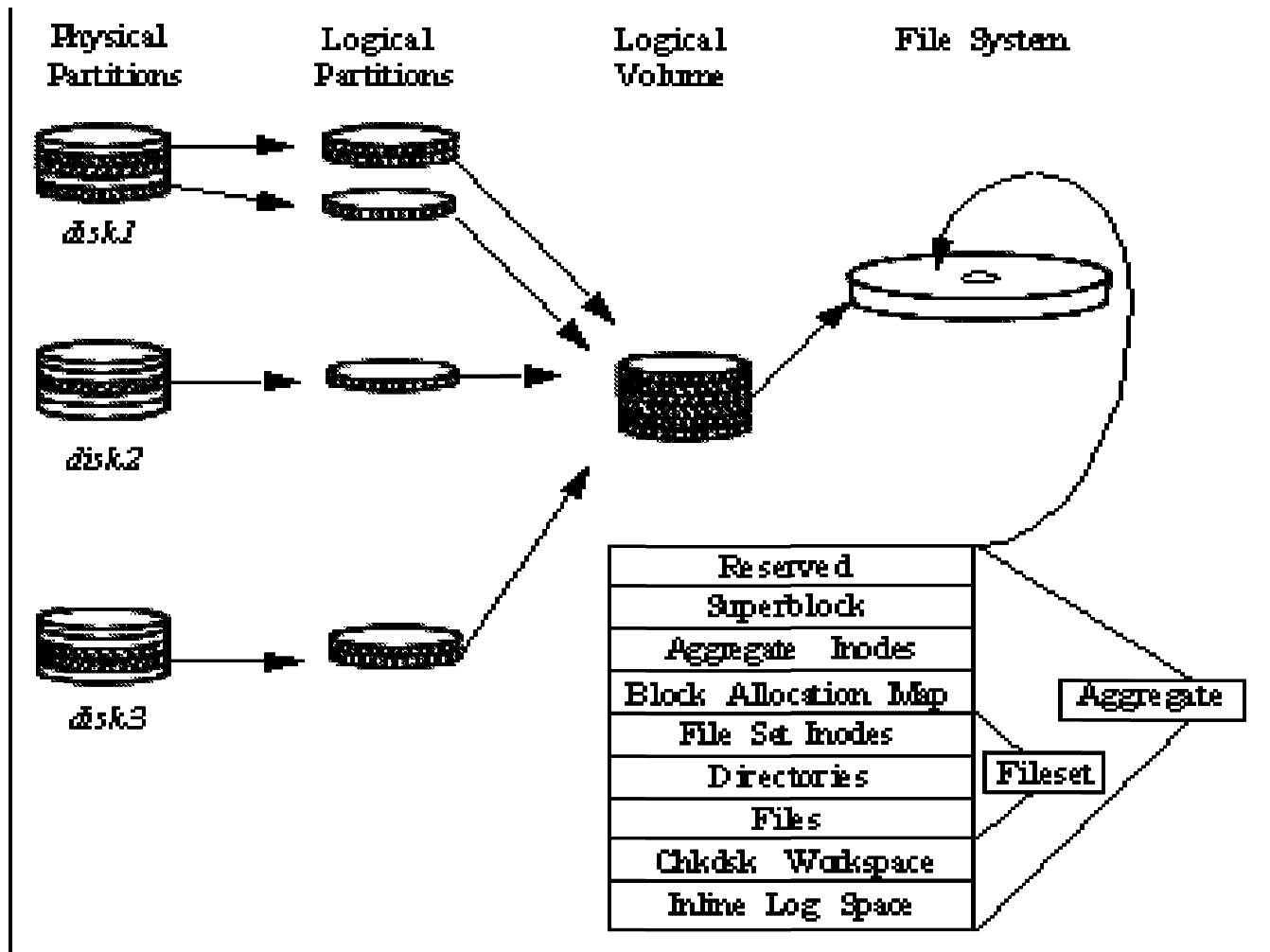

LVM Components

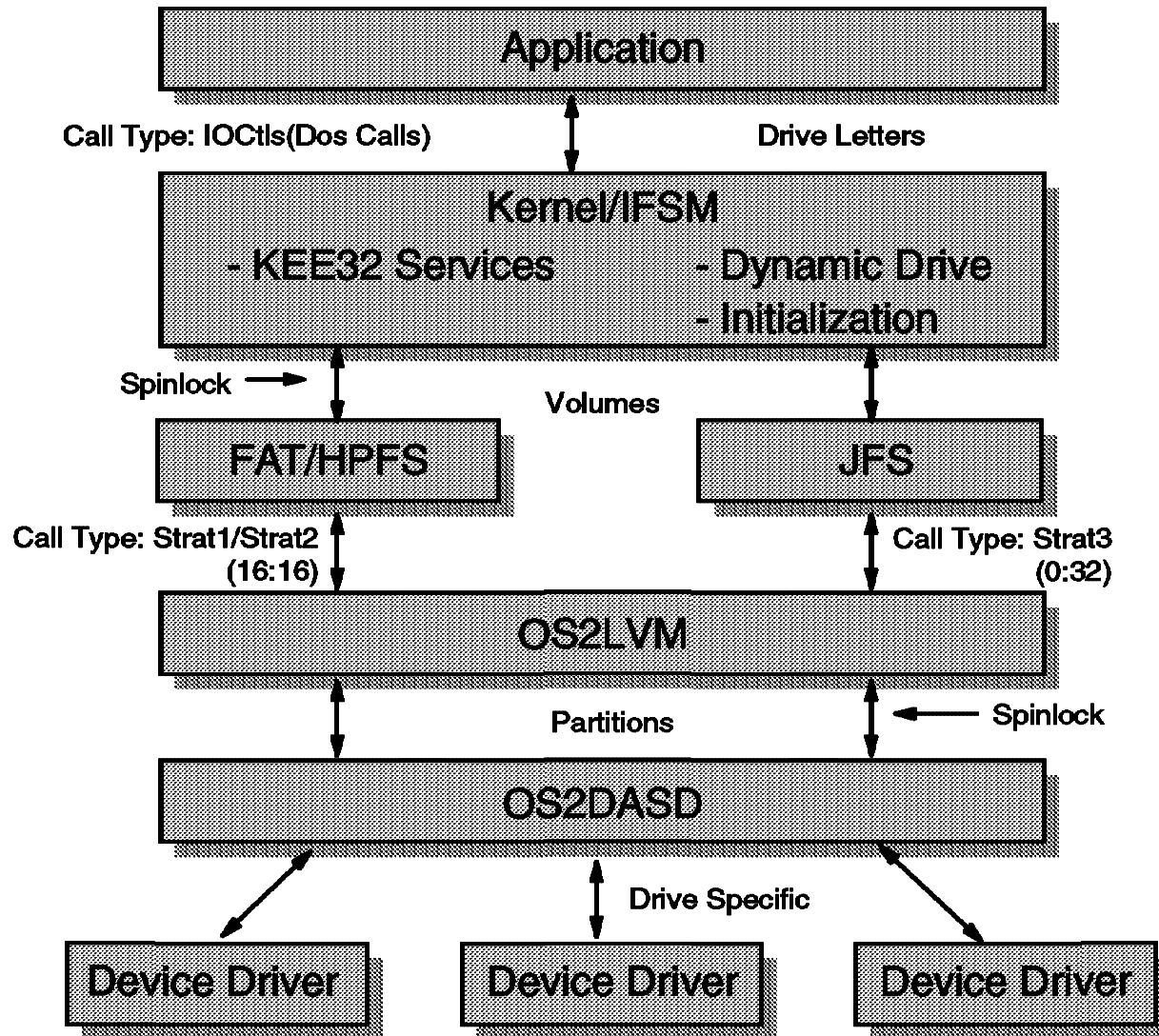

Physical View via LVM

The screenshot shows the 'Logical Volume Management Tool - Physical View' window. It contains two tables. The first table lists physical disks with columns for Physical Disk, Size (MB), Free Space, Total, and Largest. The second table lists disk partitions with columns for Disk Partition, Size (MB), Type, Status, and Logical Volume. A footer bar contains keyboard shortcuts: F1=help, F3=exit, F5=Logical View, Enter=Options, Tab=Window.

Physical Disk	Size (MB)	Free Space:	Total	Largest
1 Disk1	4116		2055	2055
2 DISK1	8205		4204	4204

Disk Partition	Size (MB)	Type	Status	Logical Volume
[BOOT MANAGER]	7	Primary	In use	
Aurora boot	1027	Primary	In use	Aurora
[free space 1]	2055			
data	1027	Logical	In use	data

F1=help F3=exit F5=Logical View Enter=Options Tab=Window

Physical View via LVMGUI

Logical Volume Manager - Physical Disk View

BootManager Volume Partition Tools View Help

Boot Manager FAT16 HPFS JFS Other Unknown Unformatted Free Space

Volume Name	Partition Name	Status	File System	Size(MB)	Type
[BOOT MANAGER]		Startable	Boot Manager	7	Primary

Logical View via LVM

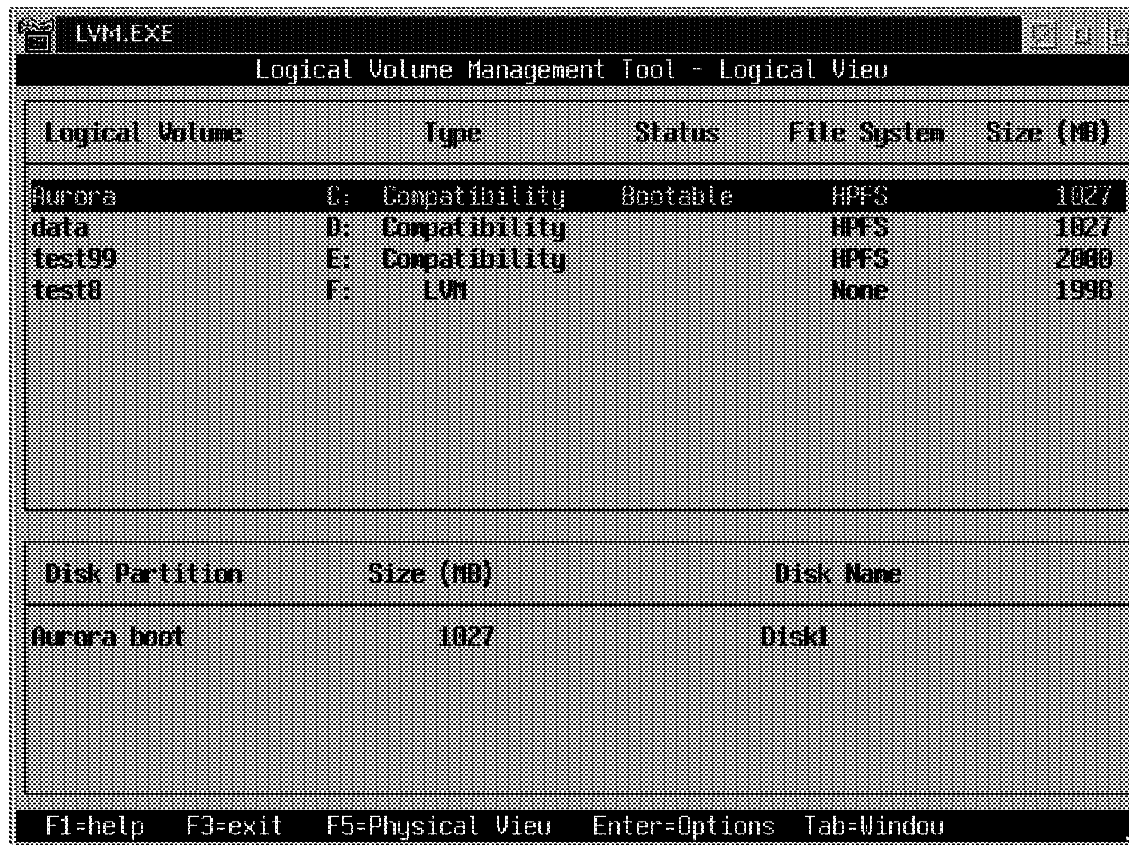

The screenshot shows the 'Logical Volume Management Tool - Logical View' window. It contains two tables. The first table lists logical volumes with columns for Logical Volume, Type, Status, File System, and Size (MB). The second table lists disk partitions with columns for Disk Partition, Size (MB), and Disk Name. A footer bar contains navigation instructions: F1-help, F3-exit, F5-Physical View, Enter=Options, Tab=Window.

Logical Volume	Type	Status	File System	Size (MB)
Aurora	D: Compatibility	Bootable	HPFS	1027
data	D: Compatibility		HPFS	1027
test99	E: Compatibility		HPFS	2000
test0	F: LVM		None	1998

Disk Partition	Size (MB)	Disk Name
Aurora boot	1027	Disk1

F1-help F3-exit F5-Physical View Enter=Options Tab=Window

Logical View via LVMGUI

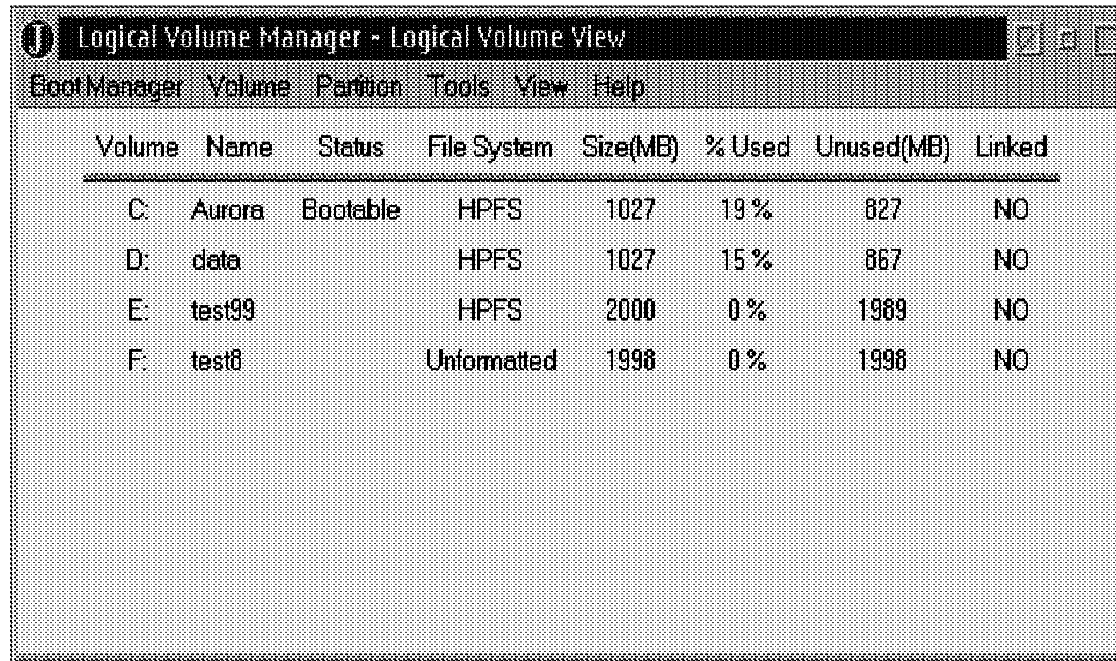

The screenshot shows a window titled "Logical Volume Manager - Logical Volume View". The window has a menu bar with "BootManager", "Volume", "Partition", "Tools", "View", and "Help". Below the menu bar is a table with the following columns: "Volume", "Name", "Status", "File System", "Size(MB)", "% Used", "Unused(MB)", and "Linked". The table contains four rows of data:

Volume	Name	Status	File System	Size(MB)	% Used	Unused(MB)	Linked
C:	Aurora	Bootable	HPFS	1027	19 %	827	NO
D:	data		HPFS	1027	15 %	867	NO
E:	test99		HPFS	2000	0 %	1969	NO
F:	test8		Unformatted	1998	0 %	1998	NO

Notes

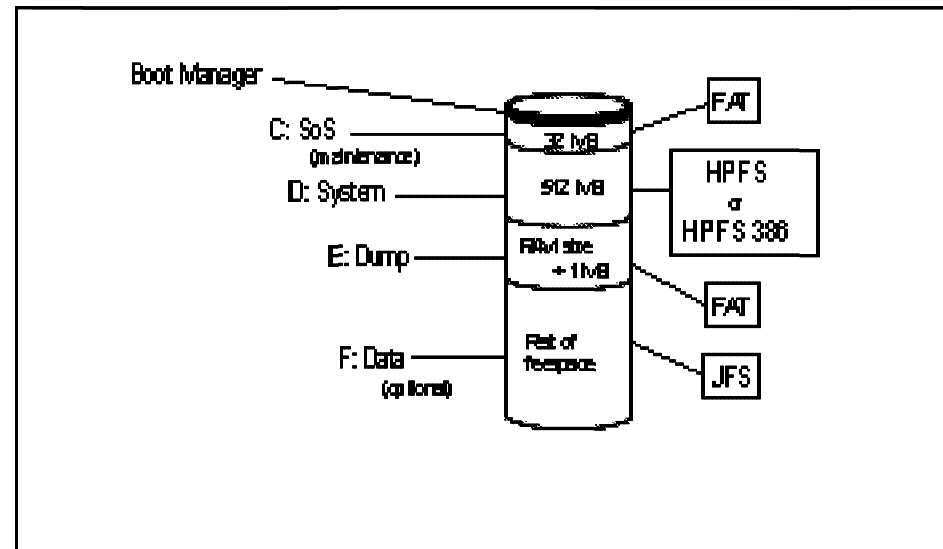

```
lvm /delete:all,volumes
lvm /delete:all,unused
lvm /delete:all,primary
lvm /delete:all,lvm
lvm /delete:all,logical
lvm /delete:all,compatibility
lvm /bootmgr:1
lvm /create:partition,SoS,1,32,primary,bootable
lvm /create:volume,compatibility,bootos2,c:,SoS,1,SoS
lvm /create:partition,system,1,512,logical,bootable
lvm /create:volume,compatibility,bootos2,d:,system,1,system
lvm /create:partition,dmp,1,129,logical,nonbootable,[FSI],fromstart
lvm /create:volume,compatibility,noboot,e:,dump,1,dump
lvm /create:partition,data,1,,logical,nonbootable,[FSI],fromstart
lvm /create:volume,lvm,f:,data,1,data
```

JFS System Structure

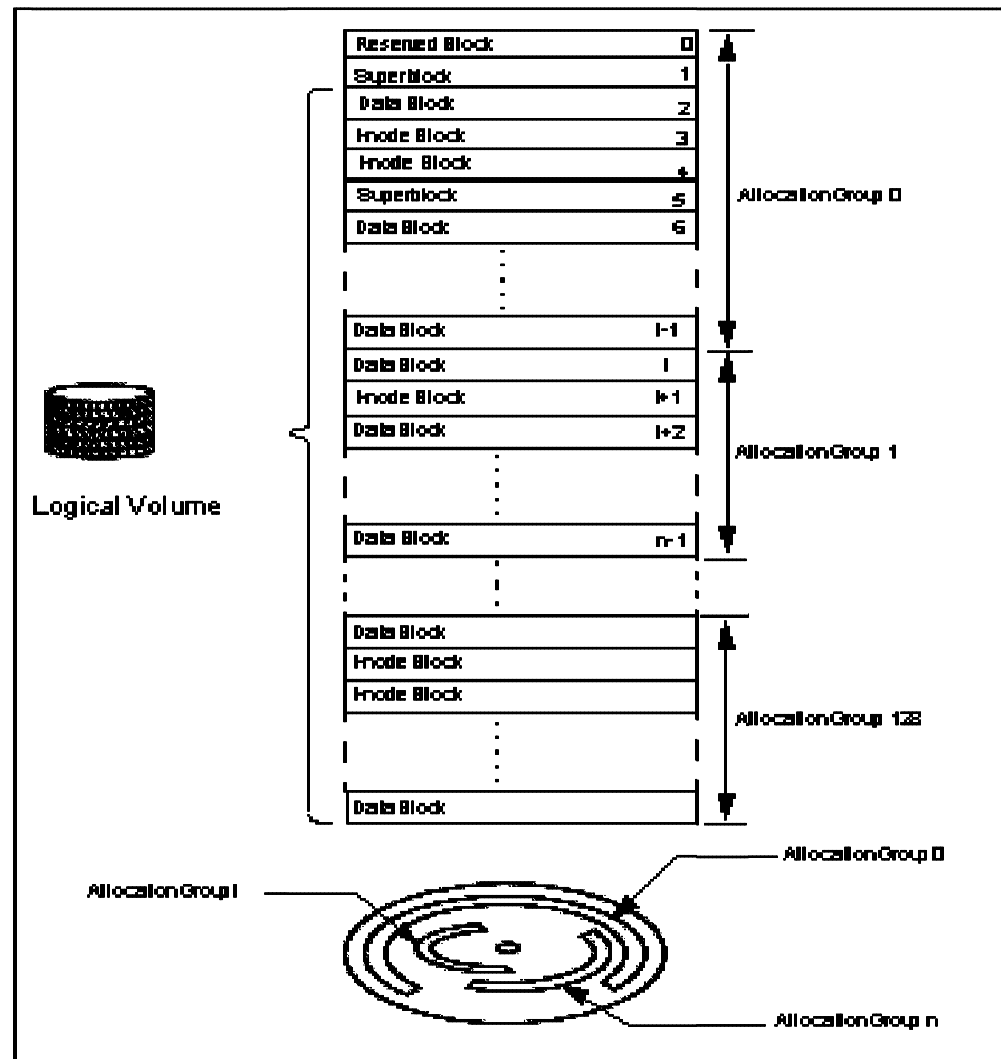

I-Node

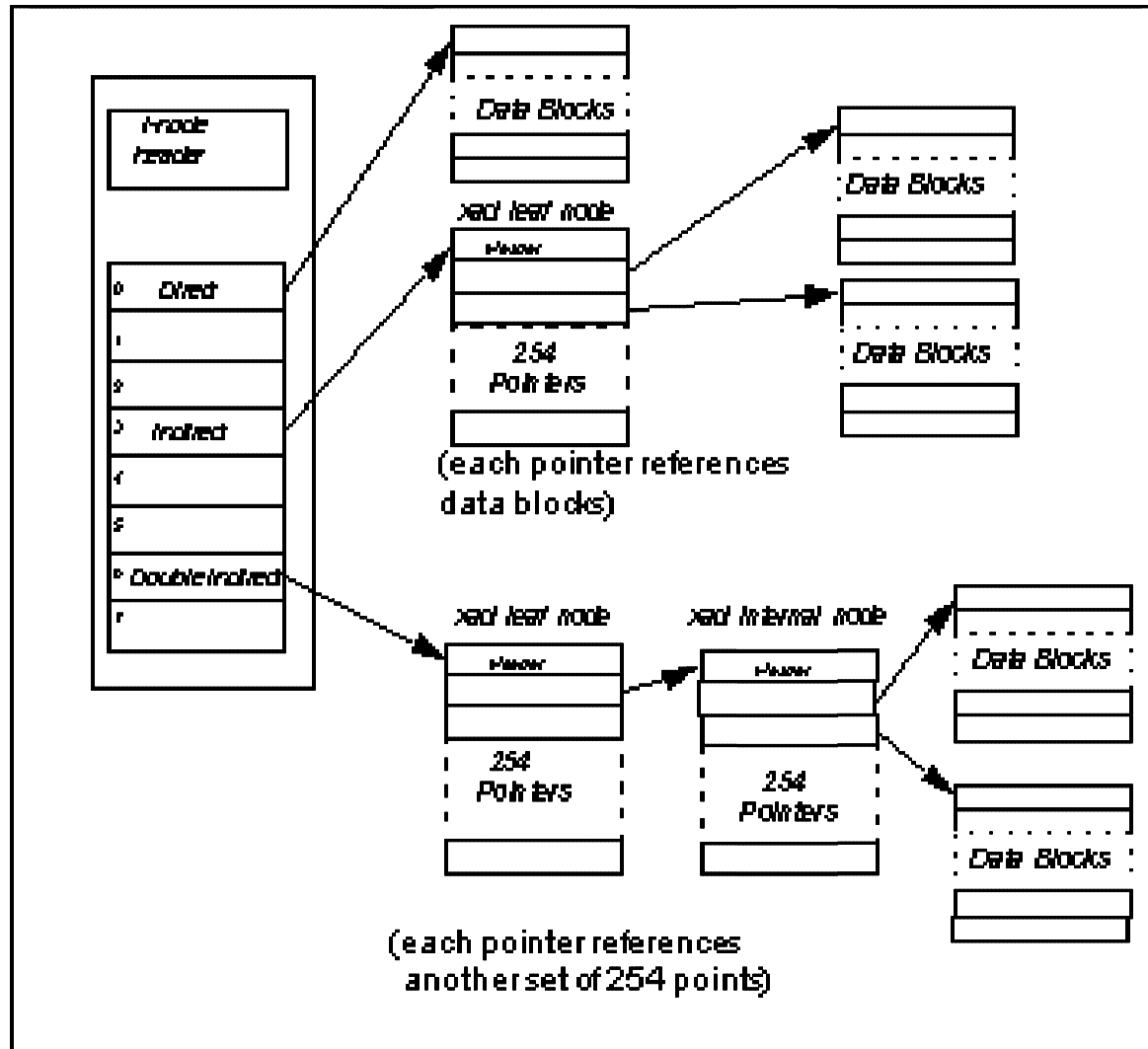

Aggregate Structure

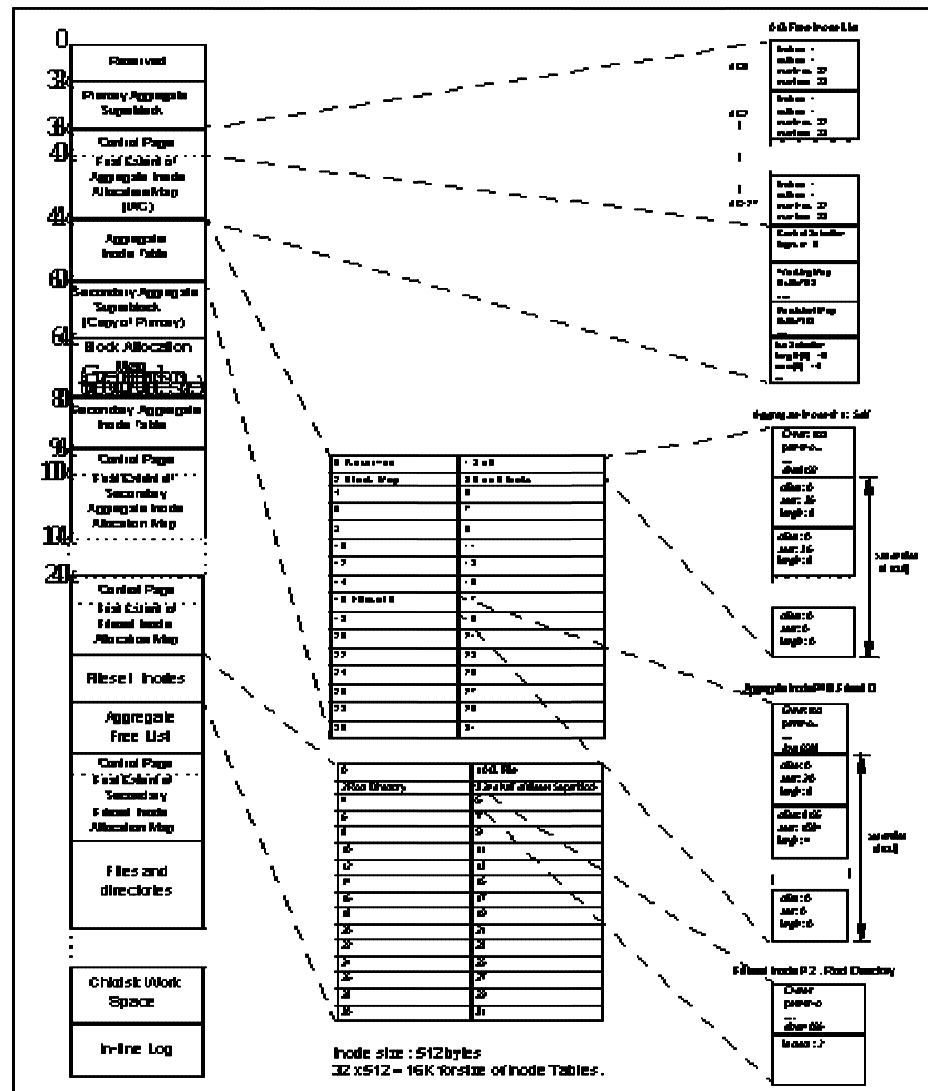

Logical Volume View

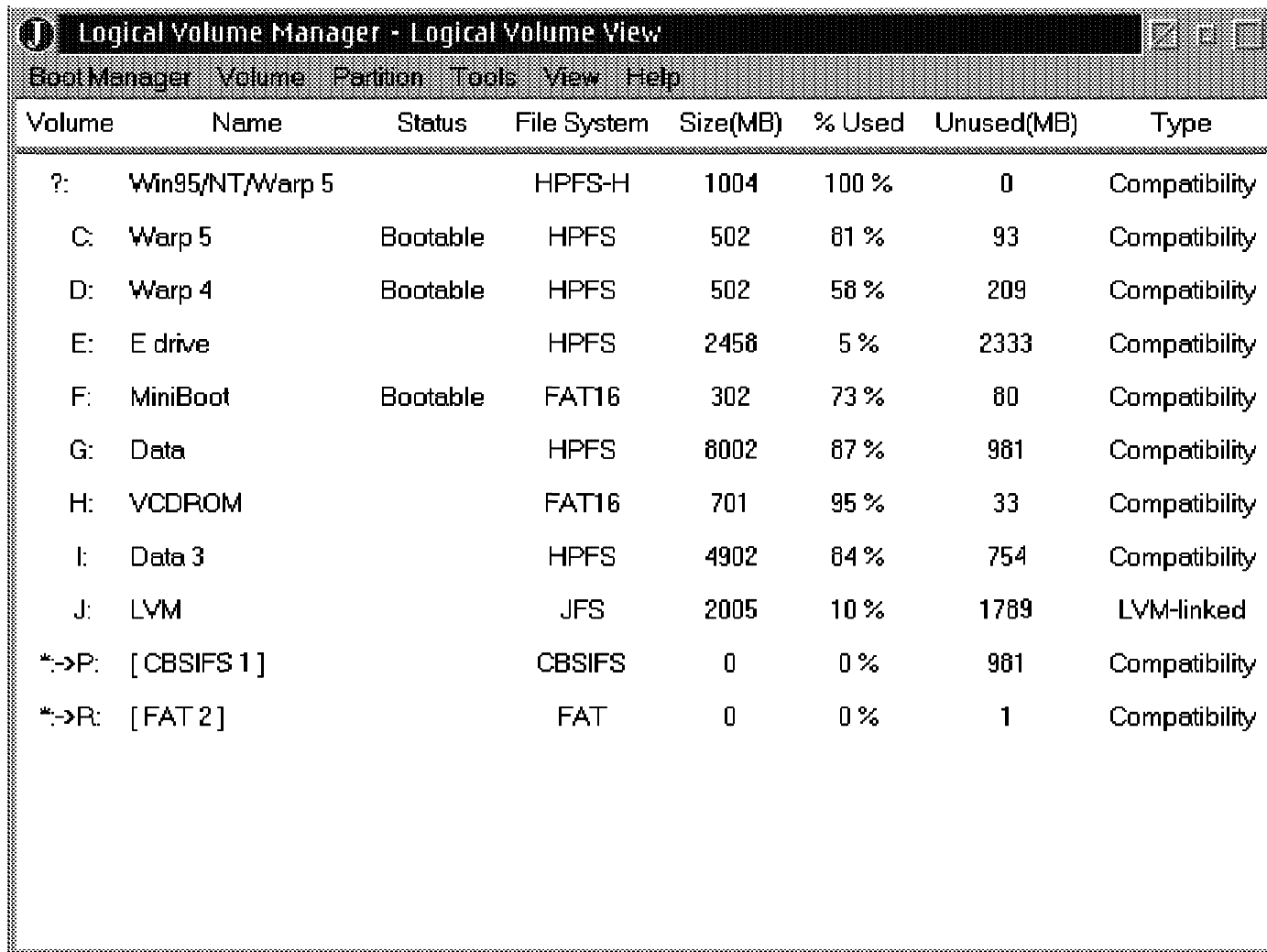

The screenshot shows a window titled "Logical Volume Manager - Logical Volume View". The window has a menu bar with "Boot Manager", "Volume", "Partition", "Tools", "View", and "Help". Below the menu bar is a table with the following columns: "Volume", "Name", "Status", "File System", "Size(MB)", "% Used", "Unused(MB)", and "Type". The table contains the following data:

Volume	Name	Status	File System	Size(MB)	% Used	Unused(MB)	Type
?:	Win95/NT/Warp 5		HPFS-H	1004	100 %	0	Compatibility
C:	Warp 5	Bootable	HPFS	502	81 %	93	Compatibility
D:	Warp 4	Bootable	HPFS	502	58 %	209	Compatibility
E:	E drive		HPFS	2458	5 %	2333	Compatibility
F:	MiniBoot	Bootable	FAT16	302	73 %	80	Compatibility
G:	Data		HPFS	8002	87 %	981	Compatibility
H:	VCDROM		FAT16	701	95 %	33	Compatibility
I:	Data 3		HPFS	4902	84 %	754	Compatibility
J:	LVM		JFS	2005	10 %	1789	LVM-linked
*->P:	[CBSIFS 1]		CBSIFS	0	0 %	981	Compatibility
*->R:	[FAT 2]		FAT	0	0 %	1	Compatibility

Personally Safe and Sound (PSnS)

- Backup set
 - Logical collection of backed up files
 - Backup media defined
 - Separate for each project/data group
 - Dual device-capable
 - File filters
 - Rule books
- Strategy
 - What data should I backup?
 - When and how often does backup occur?
 - Where should the backup be stored?
 - Fast access Hard disk or LAN alias
 - Large capacity Tape or Read/Write optical
 - Cheap storage Diskette or Removable Drive
 - Centrally managed ADSTAR

Backup Method

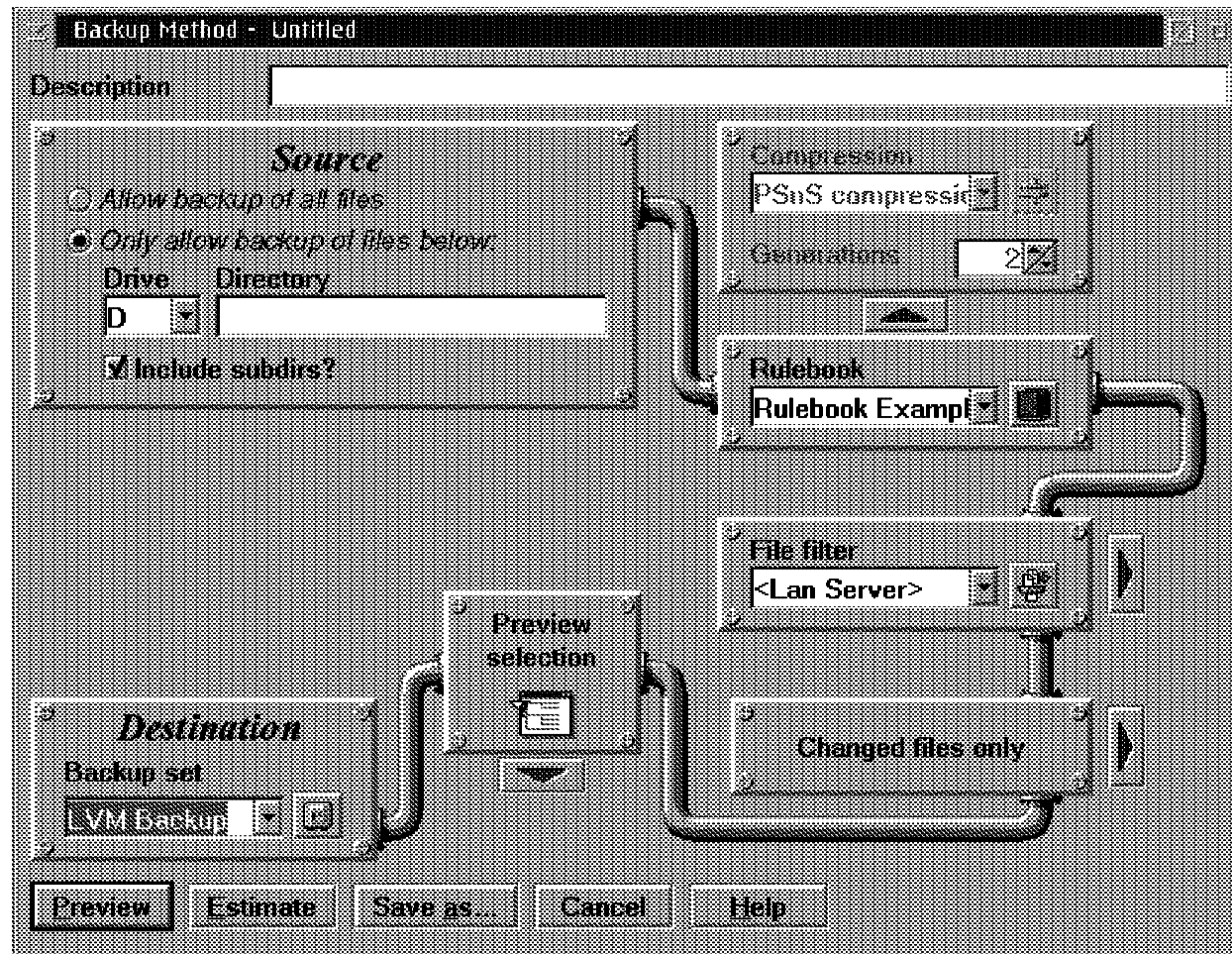

Refer to the online *PSnS Manual* for guidance and details.

Source Drives

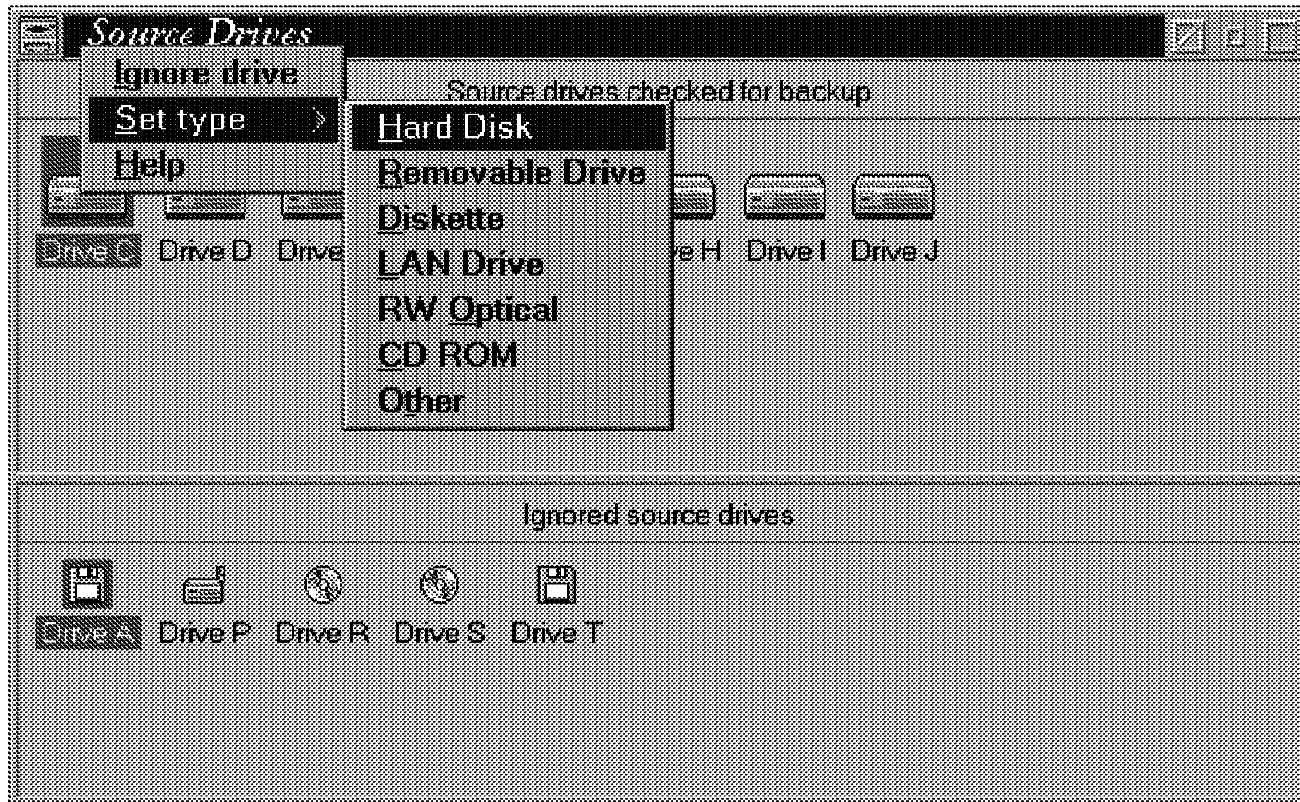

Storage Devices

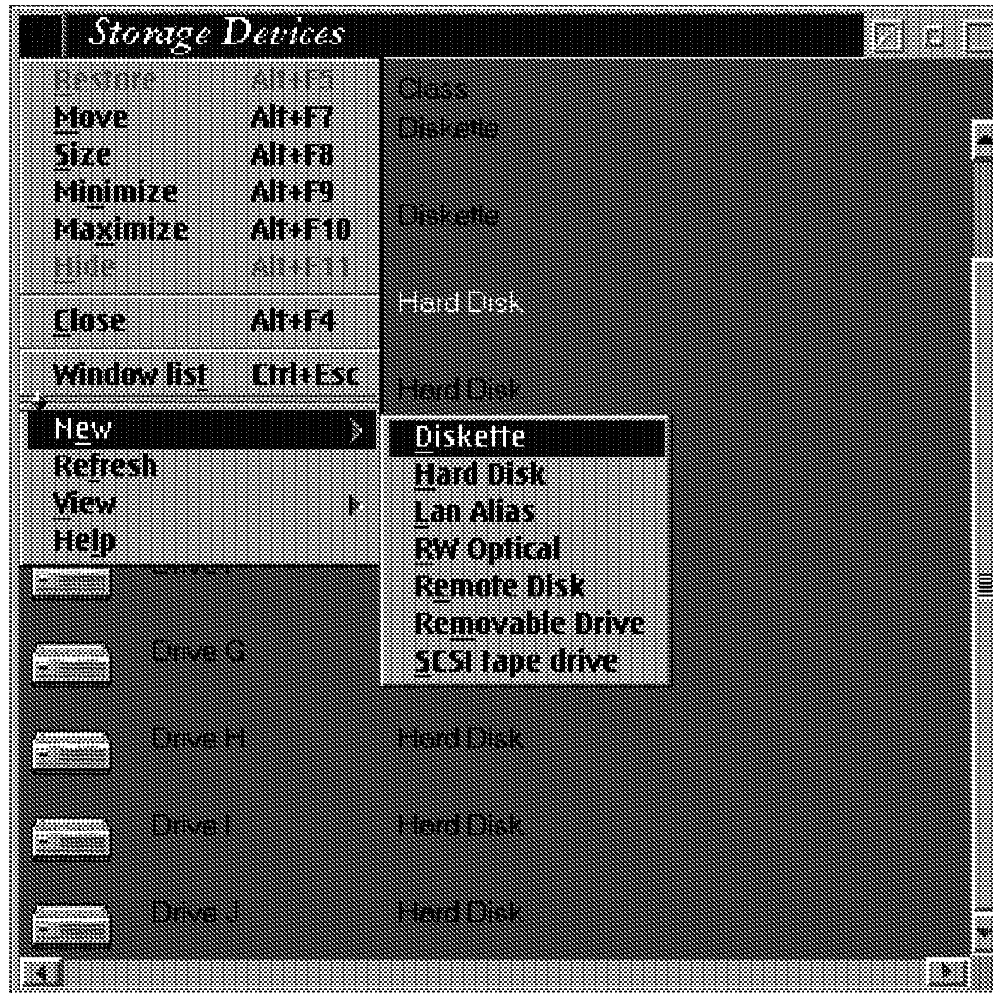

Backup Sets

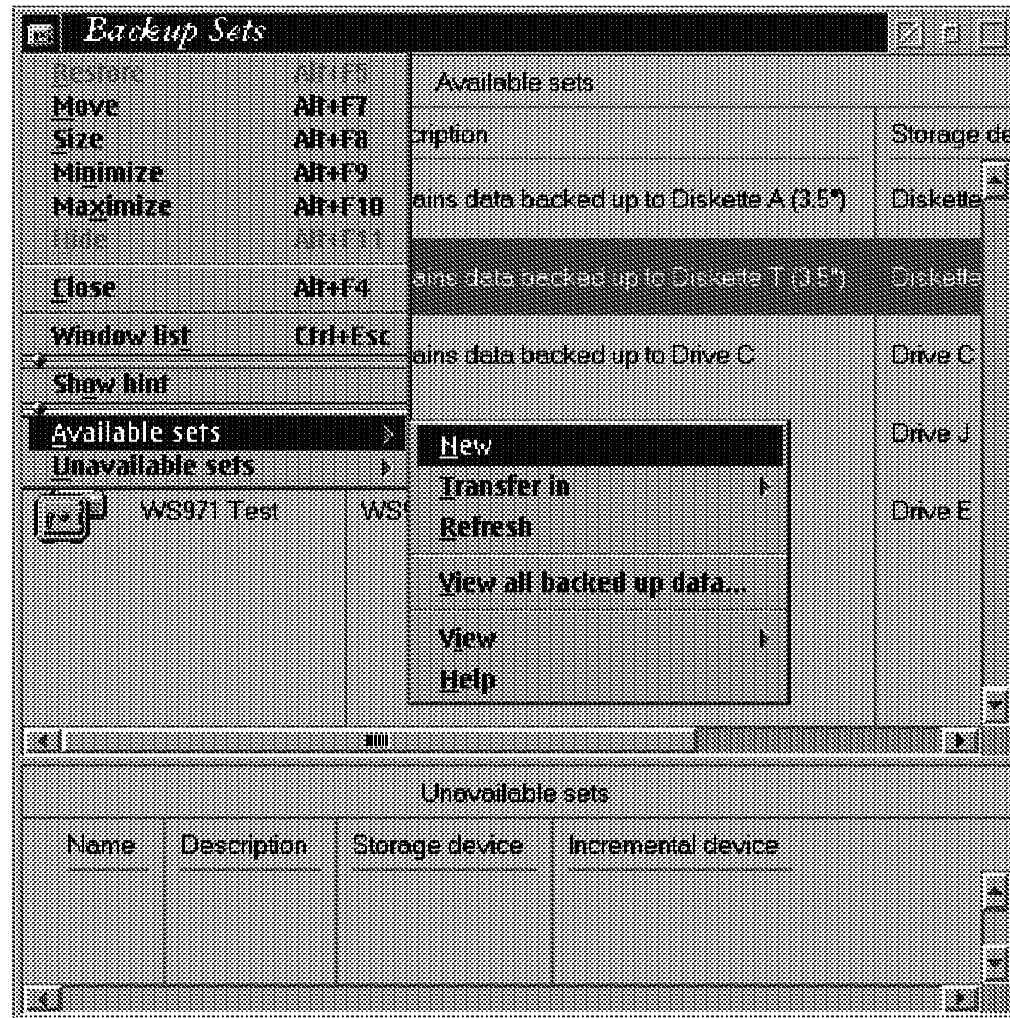

Determine Security Guidelines

- Restrict access to the network
- Restrict access to data
- Restrict physical access to servers
- Local security
 - 386 HPFS servers
 - Local security access
 - LOCAL Group
 - User logged on
- Privileged programs
 - Run at startup
 - RUNPRIV.EXE
 - PRIVINIT.CMD
 - Run from the command line
 - PRIV <command>
 - Start PRIV <command>
 - Detach PRIV <command>

Note: STARTUP.CMD does NOT have any special privileges at startup.

Network Applications

- **Application as a Resource**
 - Server stored
 - Client executed
 - Network managed (alias)
- **Private applications**
 - Created by the user for personal use
- **Public applications**
 - Created by administrator for general use
 - Install the application.
 - Create a directory alias for the application.
 - Create additional aliases other network resources
 - Assign access permissions for the aliases.
 - Define the application.
 - Customize application
 - Add the application to users or groups

Considerations

- DLL locations
 - LIBPATH, BEGINLIBPATH, ENDLIBPATH
- User unique data
 - alias, home directory
- Environment variables

Remote Execution

- Detachable programs
- runpath=
- NetRun service
- NET RUN <command.EXE>

Refer to Chapter 9 and Chapter 10 of the *Network Administrator's Guide*

IP Address Assignment

- BOOTP
- BOOTPD
 - \\ETC\\SERVICE
 - \\ETC\\BOOTPTAB
- DHCPSTRT
- DHCPD
 - DHCPD.CFG
 - DHCPD.CFG
 - DHCPMON.EXE
 - DHCPD.EXE
 - DHCPSCPC
 - DADMGUI
- NAMED
 - DDNSAPC
 - DDNSCFG
 - DHCPD.CFG
 - NSUPDATE

File Transfer

- FTP
- FTPD
- TFTP
 - NetRC.DAT
 - TCPCFG2
 - TRUSERS
 - TFTPAUTH
- NFS
- NFSD
 - TCPCFG2
 - "exports" file
 - TCPNBK.LST
 - MOUNT / UNMOUNT
 - SHOWEXP
 - SHOWMOUN

TCP/IP Printing

- LPD
- LPQ
- LPR
- LPRM
- LPRMON
- LPRPORTD

Remote Access

- TELNET
- TELNETD
 - NETSP
 - "SHELL"
- REXEC
- REXECD
- RSH
 - RHOSTS
 - TCPCFG2

Unit Summary

You should now be able to:

- Perform initial network administration tasks checklist
- Start, stop, and pause server services
- Access the network from various systems
- Manage domains
- Define and share network resources
- Create and apply access control profiles
- Manage network printing
- Define and manage users and groups
- Manage and add volumes and partitions
- Implement backup and recovery
- Manage network security
- Create and manage server applications

Unit 5. Administering Installation Specific Tasks in OS/2 Warp Server for e-business

Objectives

After completing this unit, you should be able to:

- Manage file and DCDB replication
- Tune a OS/2 Warp Server for e-business network
- Perform additional network task
- Perform multiple Client/Server integration
- Understand how to install, configure, and manage remote IPL services

Setting Up the Exporter

REPLINI - in first-level directory

extent = FILE/TREE <how far>

integrity = FILE/TREE <how stable>

User ID and password for importer

IBMLAN.INI

replicate=export

exportpath=absolute path to the exporting trees

exportlist=importer receiving updates

srvservices

guardtime=0-interval/2

interval=1-60

pulse=1-10

random=1-120

REPLICATOR to wrkservices section.

Access profile for export directory (tree)

Importer access to export directory

NET START REPLICATOR

Setting Up the Importer

First Level Import directory

Single import path

IBMLAN.INI

replicate=import

importpath=absolute path to the importing tree

importlist=exporter1;exporter2 sending updates

tryuser=yes

REPLICATOR to wrkservices section.

logon=importer's logon ID

password=importer's password

NET START REPLICATOR

DCDB Replication

- Subset of Replication

DCDB Exporter

REPL.INI in each subdirectory of IBMLAN\DCDB

extent = tree

integrity = file

Automatic management of USERLOCK.xxx

Don't create or remove

IBMLAN.INI (DCDBREPL section)

interval = 5

guardtime = 2

pulse = 3

random = 60

Add DCDBREPL to srvservices

DCDB Importer

IBMLAN.INI (DCDBREPL section)

tryuser = yes

logon = userid (administrator)

password = password

Add DCDBREPL to srvservices

Verify the following subdirectories exist:

C:\BMLAN\DCDB\USERS

C:\BMLAN\DCDB\DEVICES

C:\BMLAN\DCDB\PRINTERS

C:\BMLAN\DCDB\APPS

C:\BMLAN\DCDB\FILES

C:\BMLAN\DCDB\LISTS

C:\BMLAN\DCDB\DATA

NET STOP DCDBREPL

NET START DCDBREPL

Tuning

- Capacity Tuning
- Performance Tuning
- Extensive Online reference
- *Performance Tuning Guide*
- "Still much of an art"
- IBM Tuning Assistant

Tuning Assistant (1 of 11)

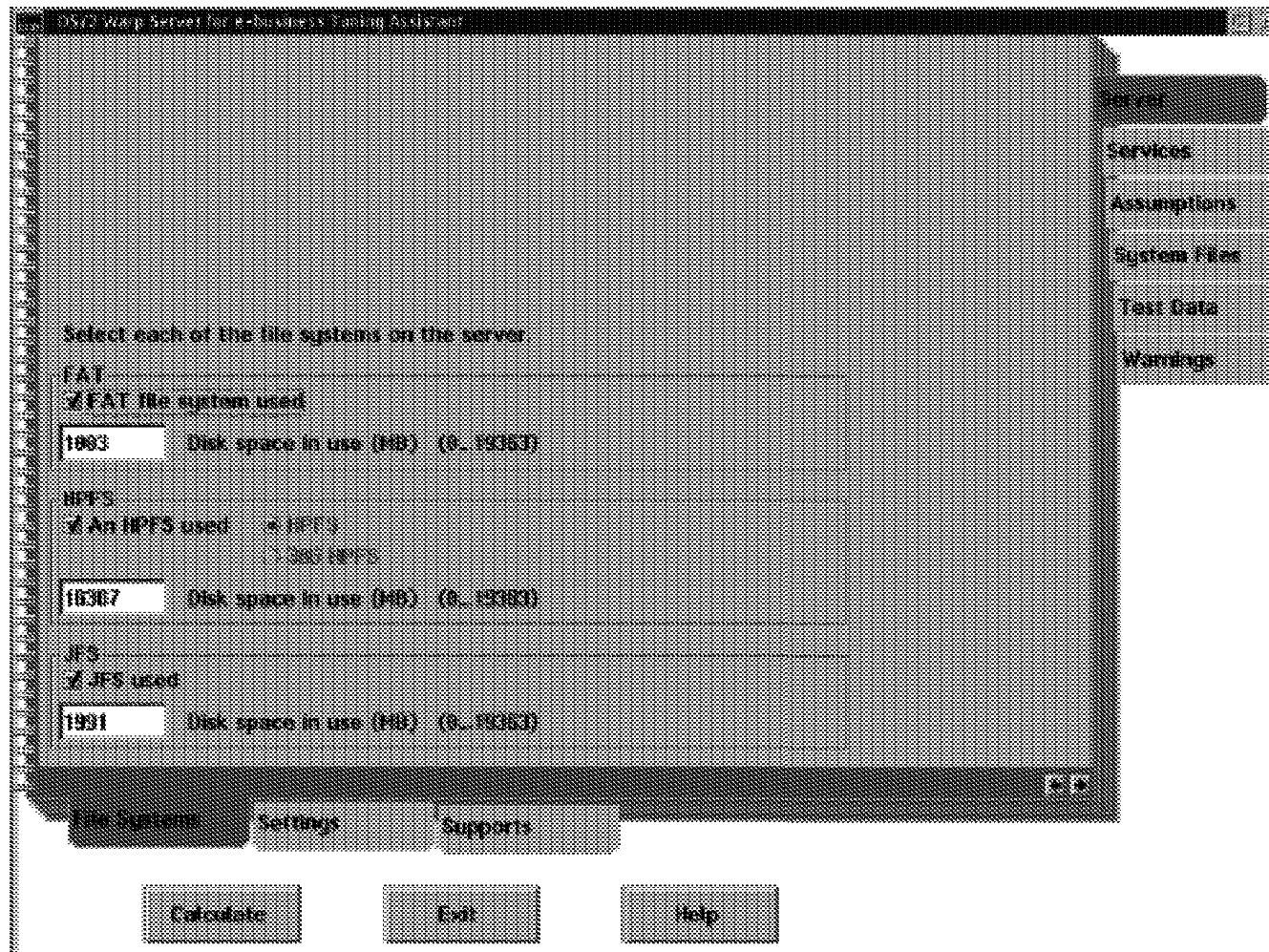

Tuning Assistant (2 of 11)

OS/2 Warp Server for e-business Tuning Assistant

Server
Services
Assumptions
System Files
Test Data
Warnings

LAN Requesters

<input type="text" value="100"/>	Number of DOS LAN Requesters	(0..250)
<input type="text" value="100"/>	Number of DOS LAN Requesters w/Windows	(0..100)
<input type="text" value="0"/>	Number of OS/2 Requesters	(0..150)

Total LAN Requesters: 100

Number of home directories (0..1000)
 Number of printer and file aliases (0..1500)
 Number of Additional Servers in the domain (0..1000)
 Number of LAN attached printers used (0..24)

File Systems Settings Supports

Calculate Exit Help

Tuning Assistant (3 of 11)

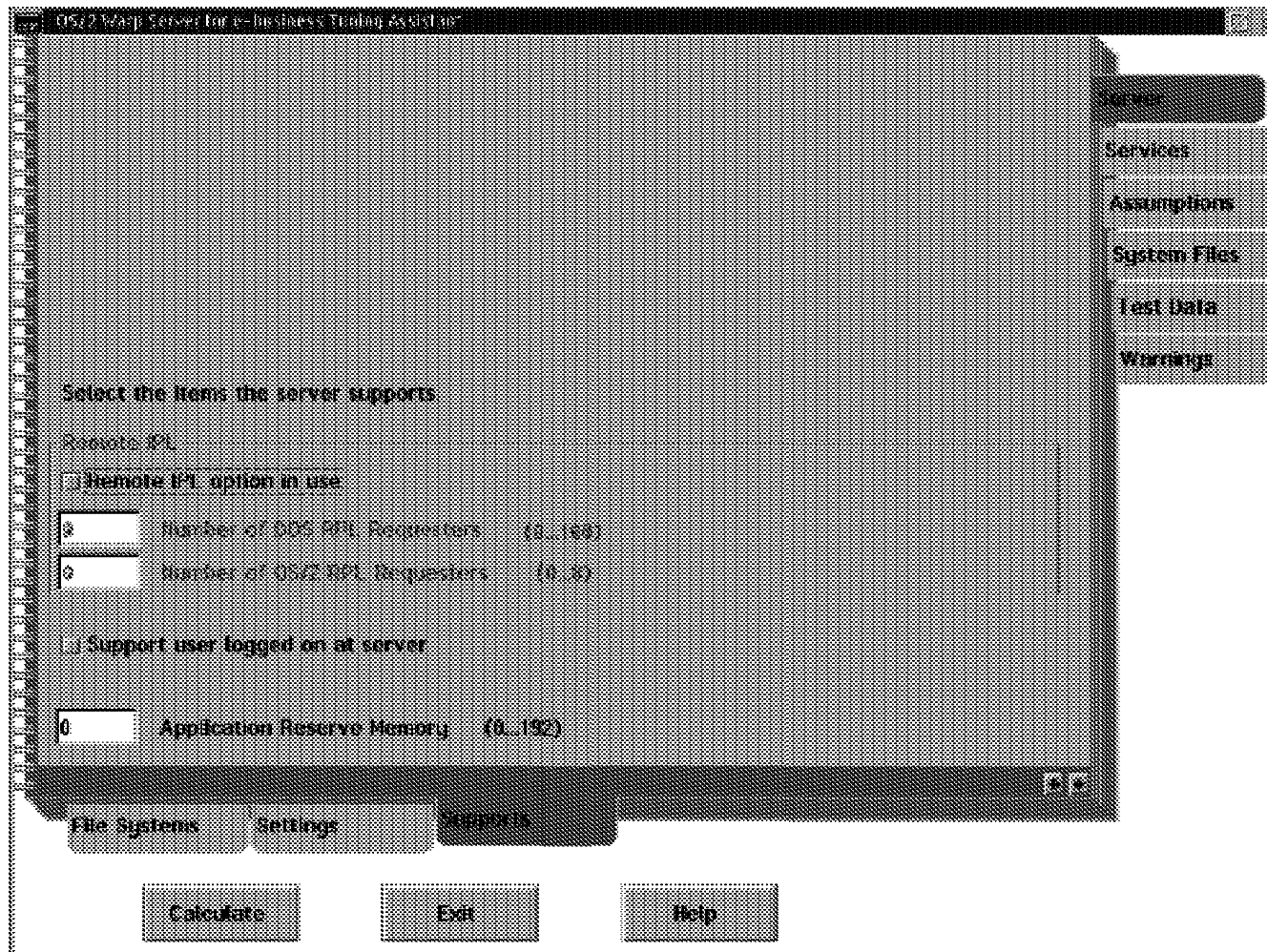

Tuning Assistant (4 of 11)

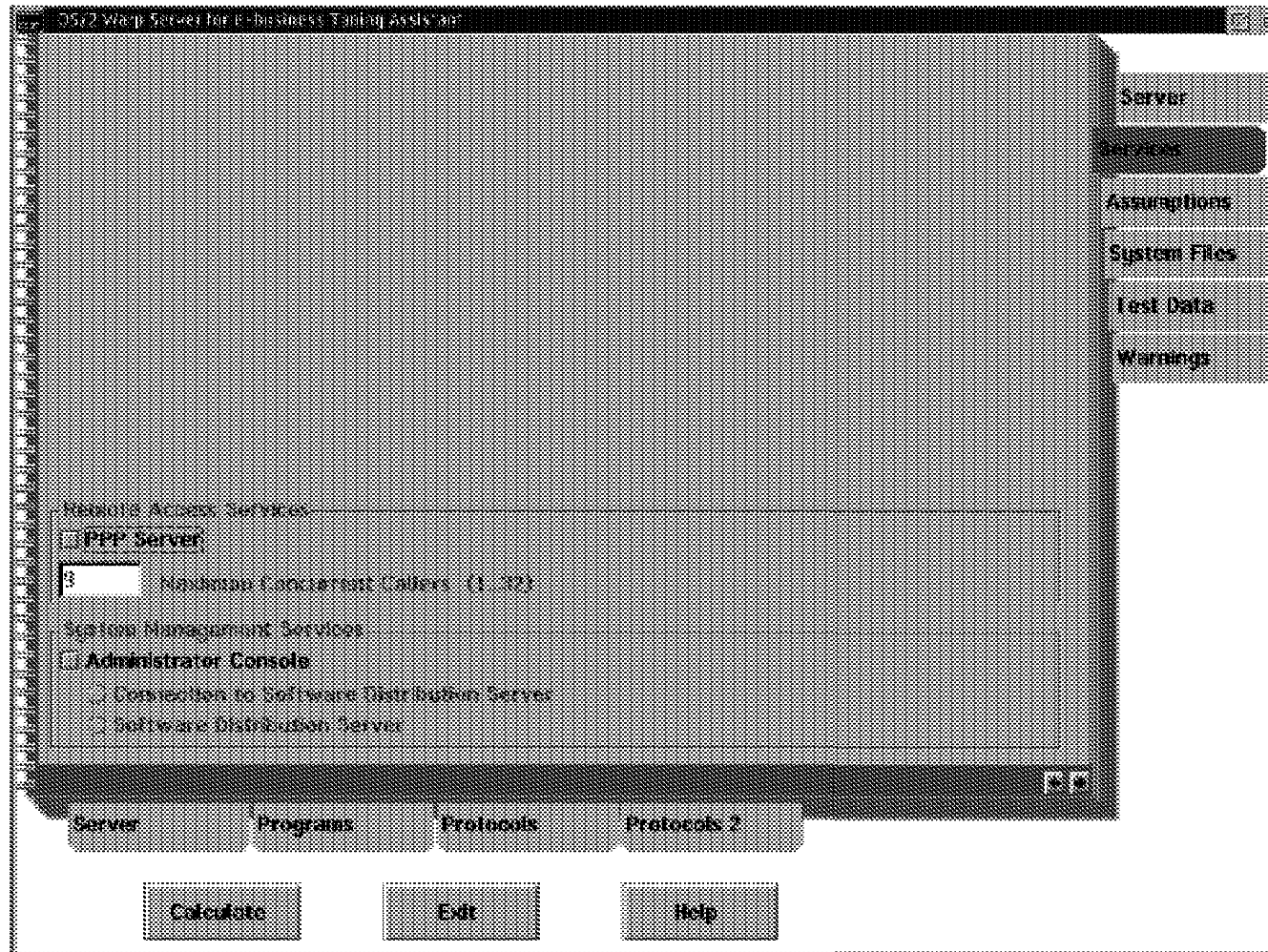

Tuning Assistant (5 of 11)

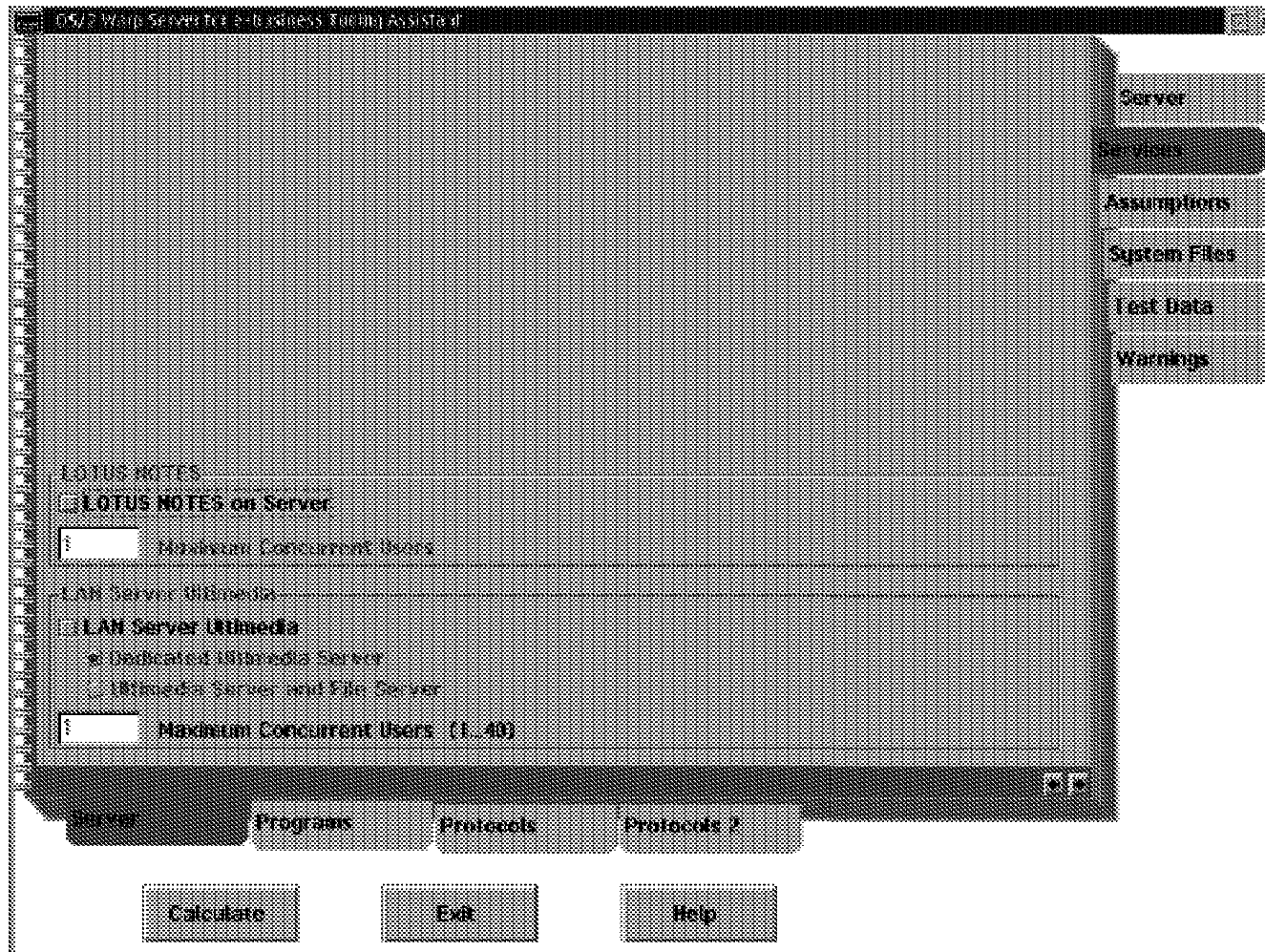

Tuning Assistant (6 of 11)

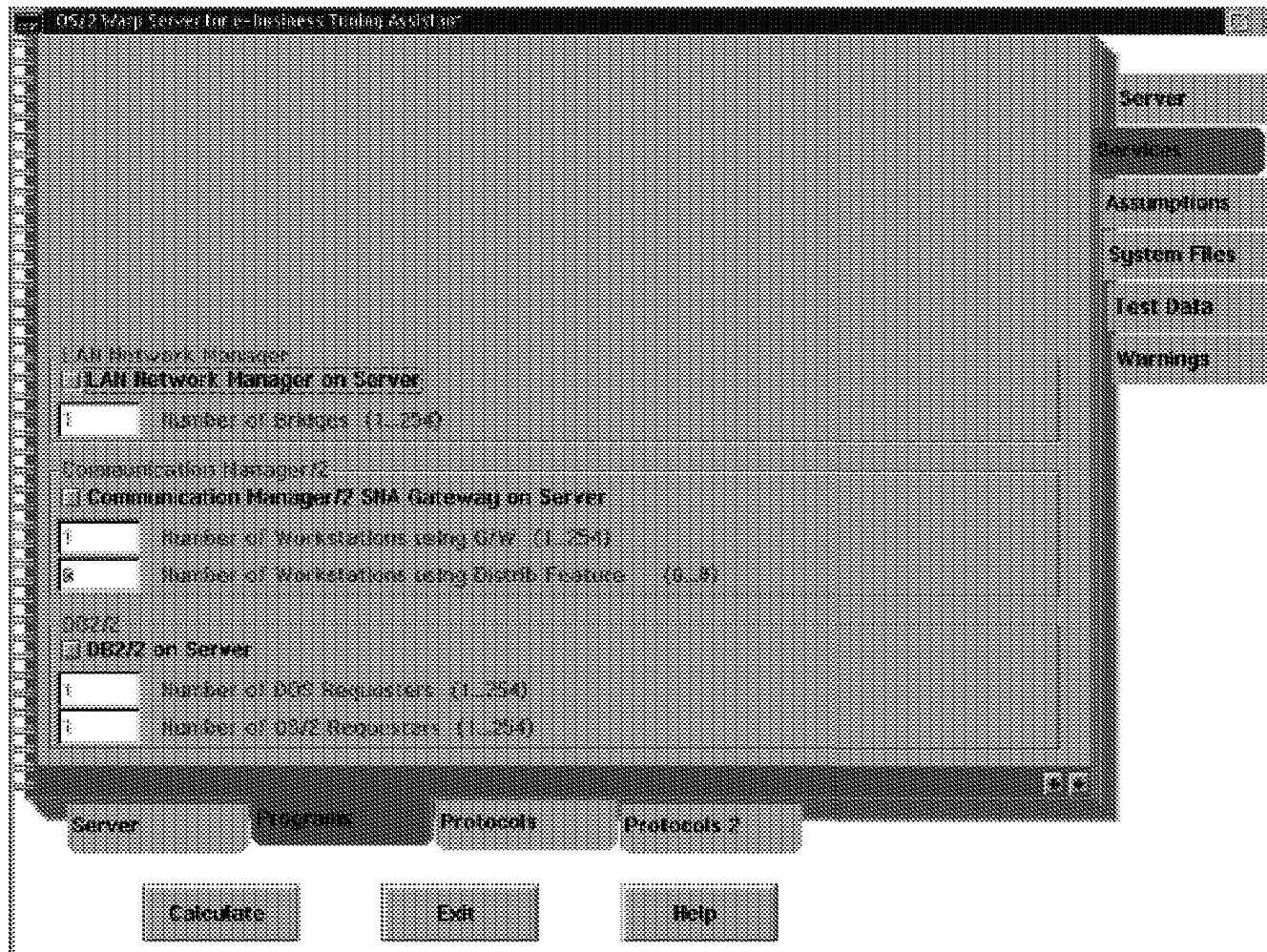

Tuning Assistant (7 of 11)

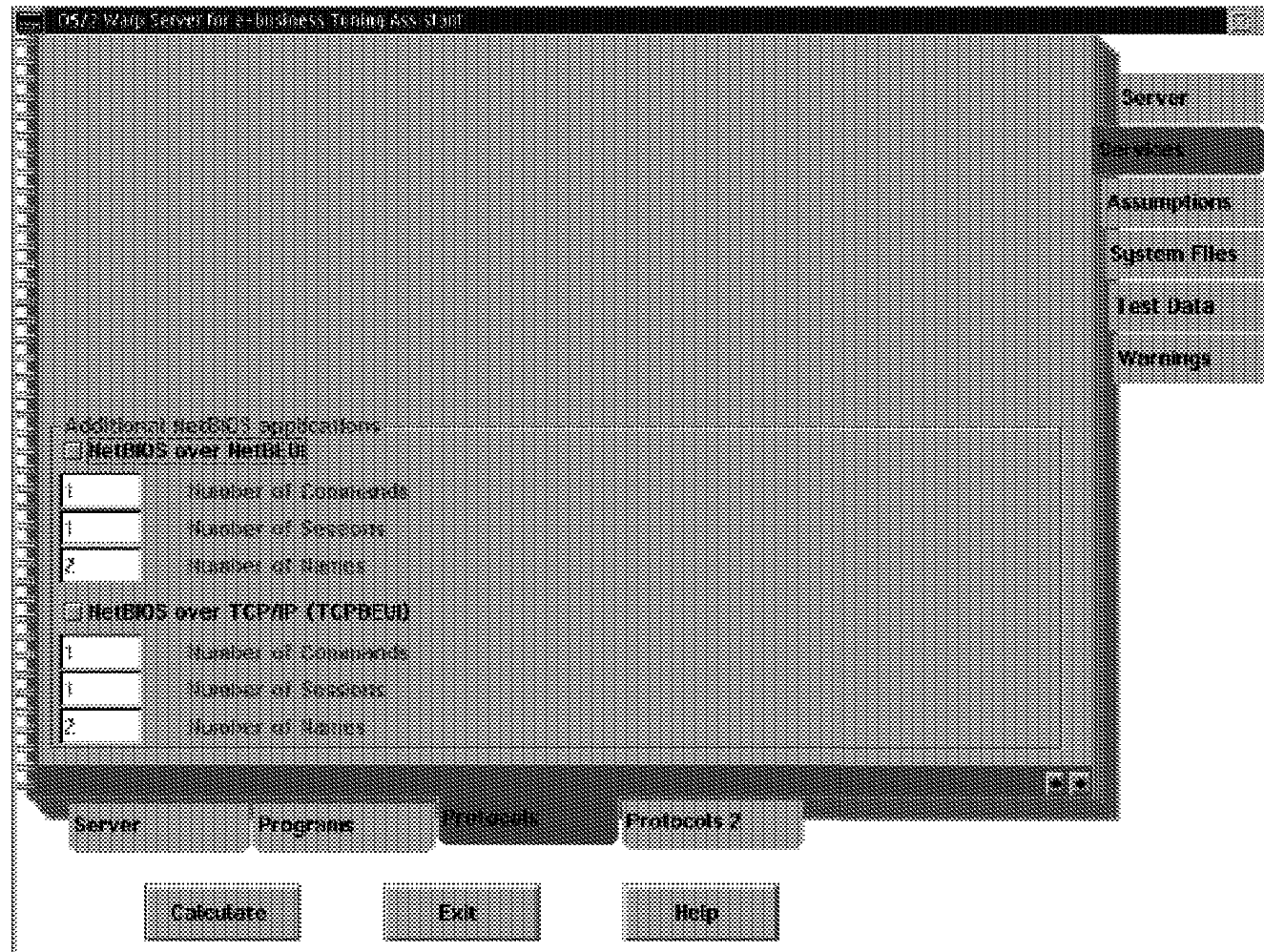

Tuning Assistant (8 of 11)

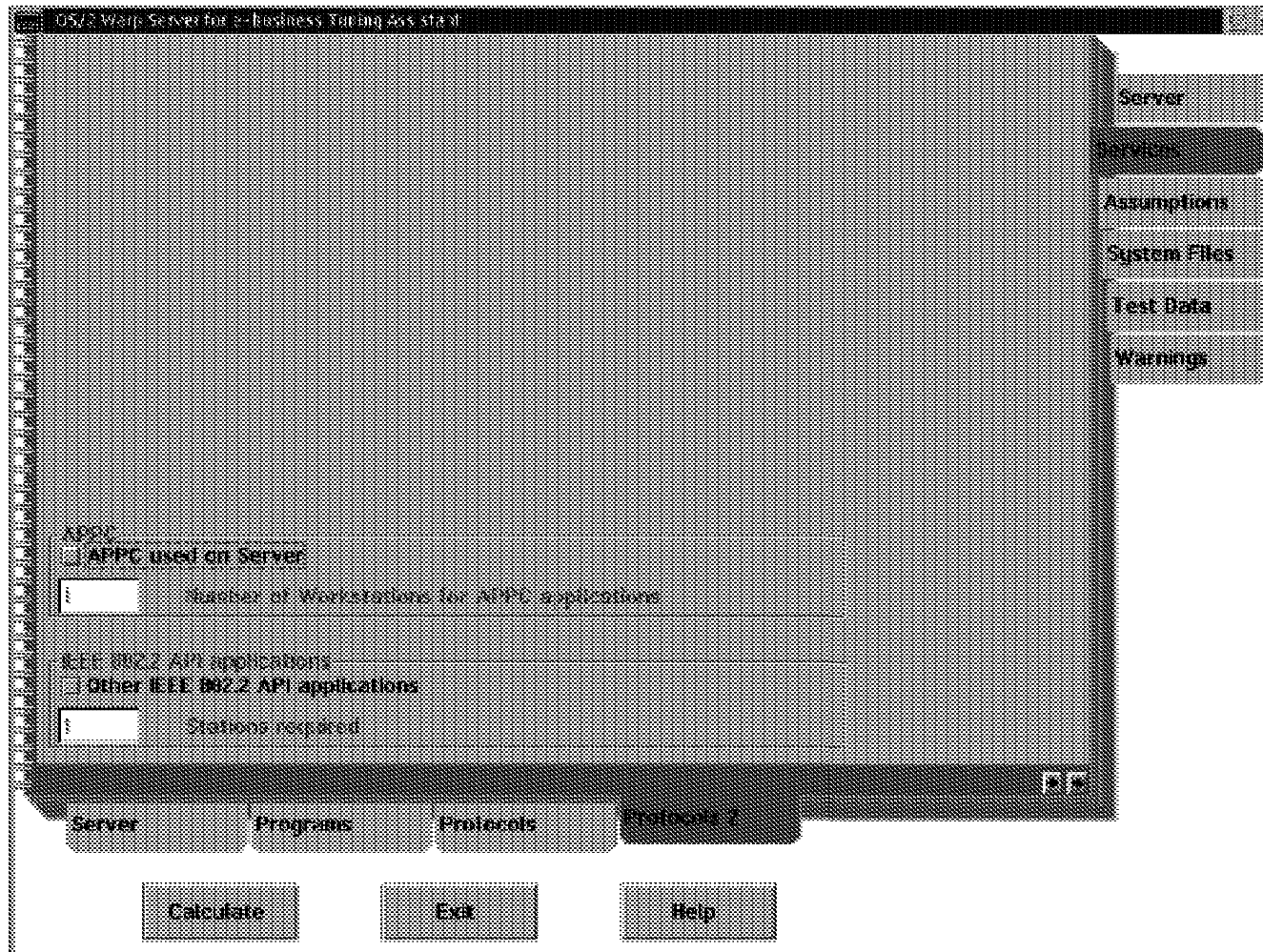

Tuning Assistant (9 of 11)

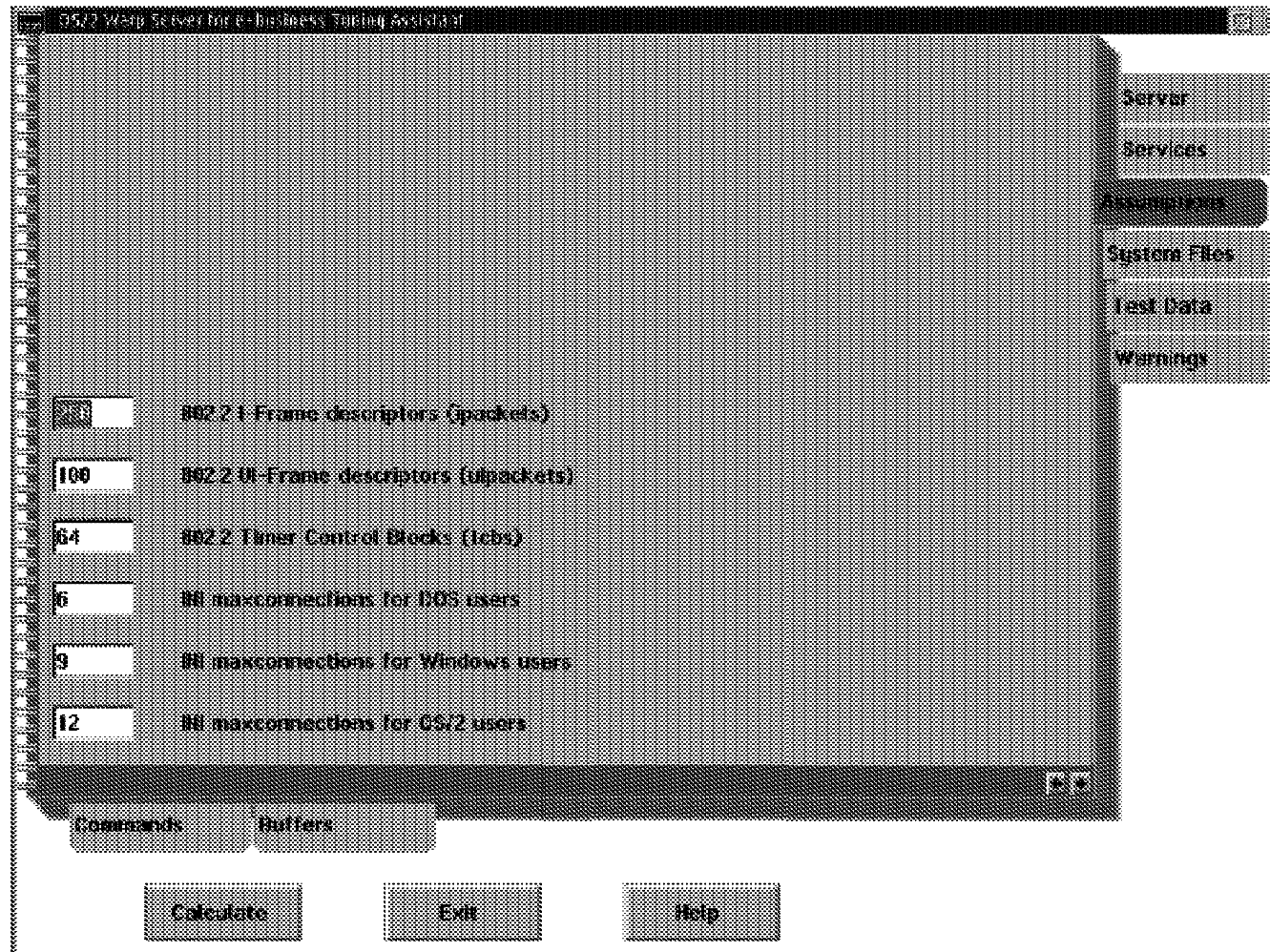

Tuning Assistant (10 of 11)

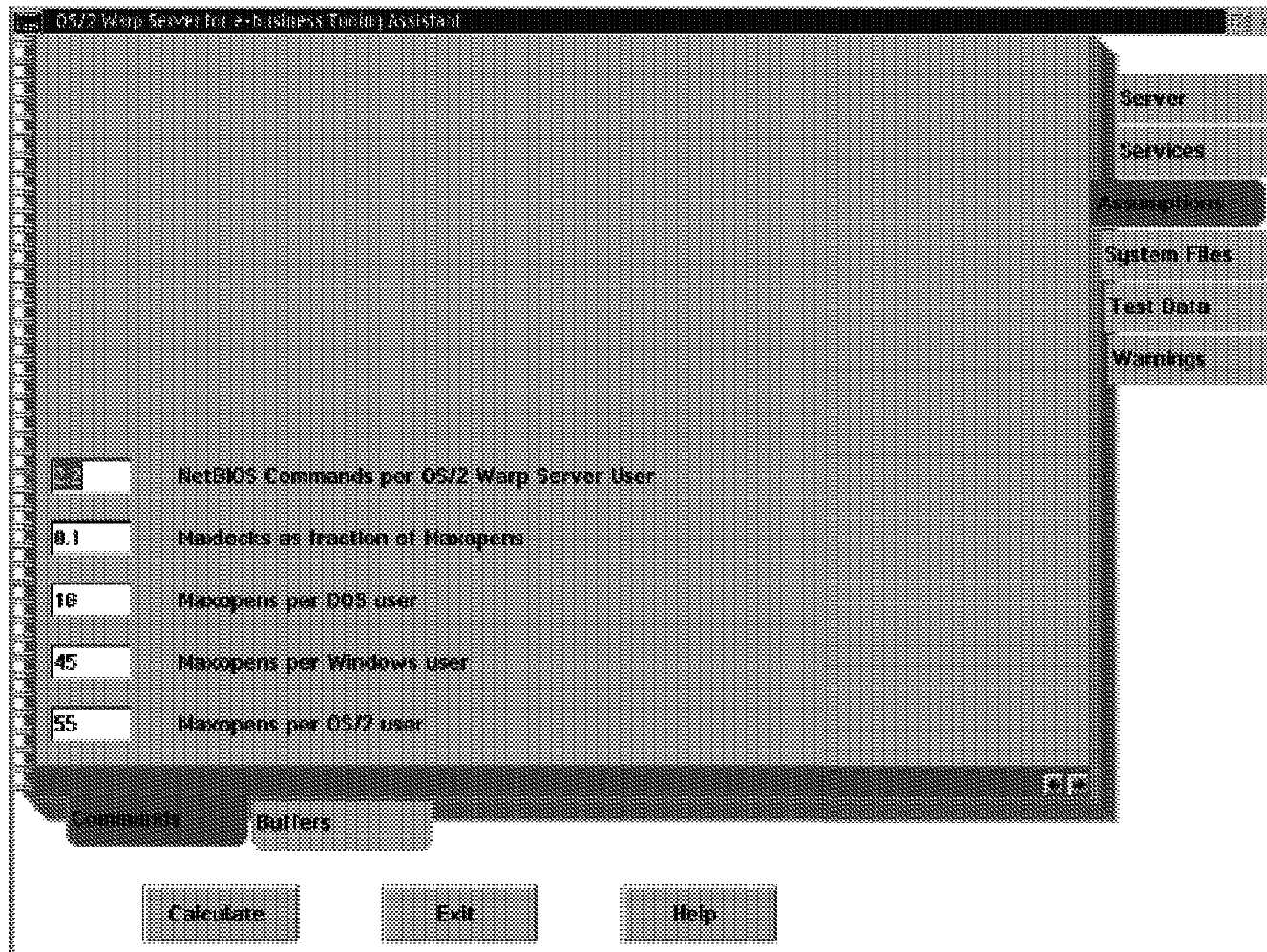

Tuning Assistant (11 of 11)

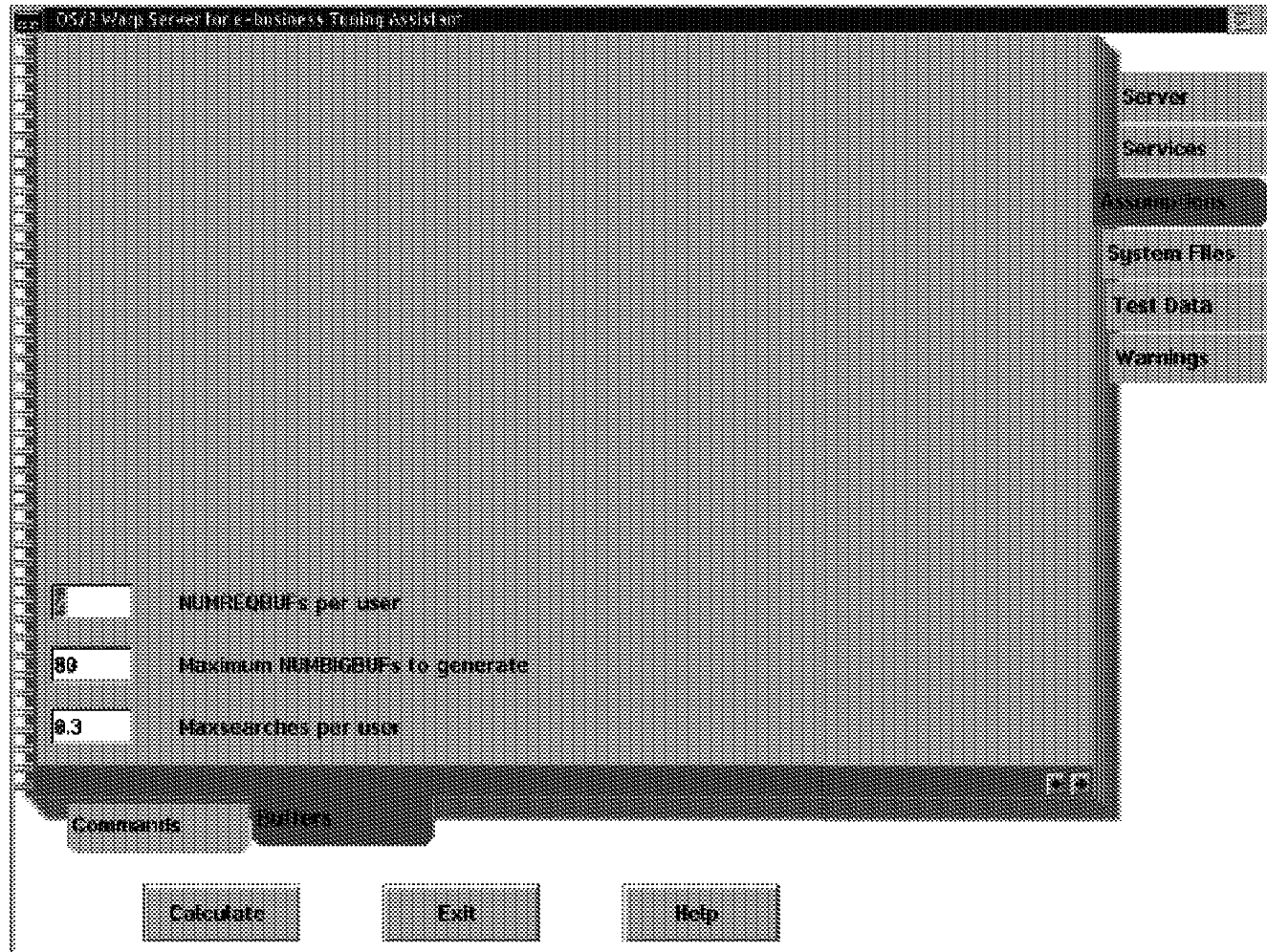

Parameters for Servers and Client

- **IBMLAN.INI**
- **PROTOCOL.INI**

LAN Administration GUI (1 of 2)

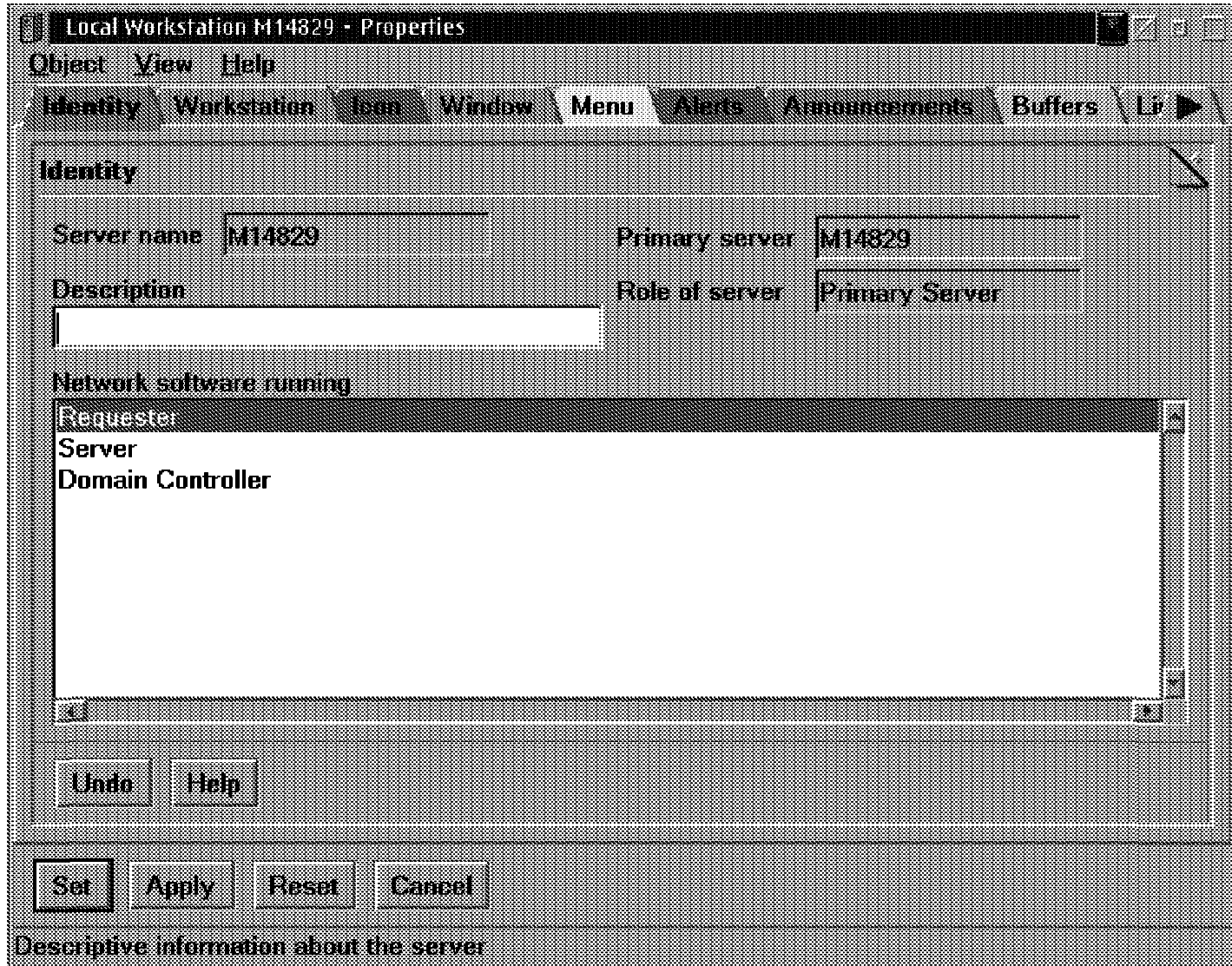

LAN Administration GUI (2 of 2)

The screenshot shows a window titled "Local Workstation M14829 - Properties". The "Workstation" tab is selected, showing the following fields:

Computer name	M14829	Other accesses	
Default access	TONN	Root directory	C:\BMLAN
Logon			
Logged on user	DENIS	Logon access	TONN

At the bottom of the window, there are buttons for "Help", "Set", "Apply", "Reset", and "Cancel". A link "Display help for settings" is also present.

Parameters (1 of 12)

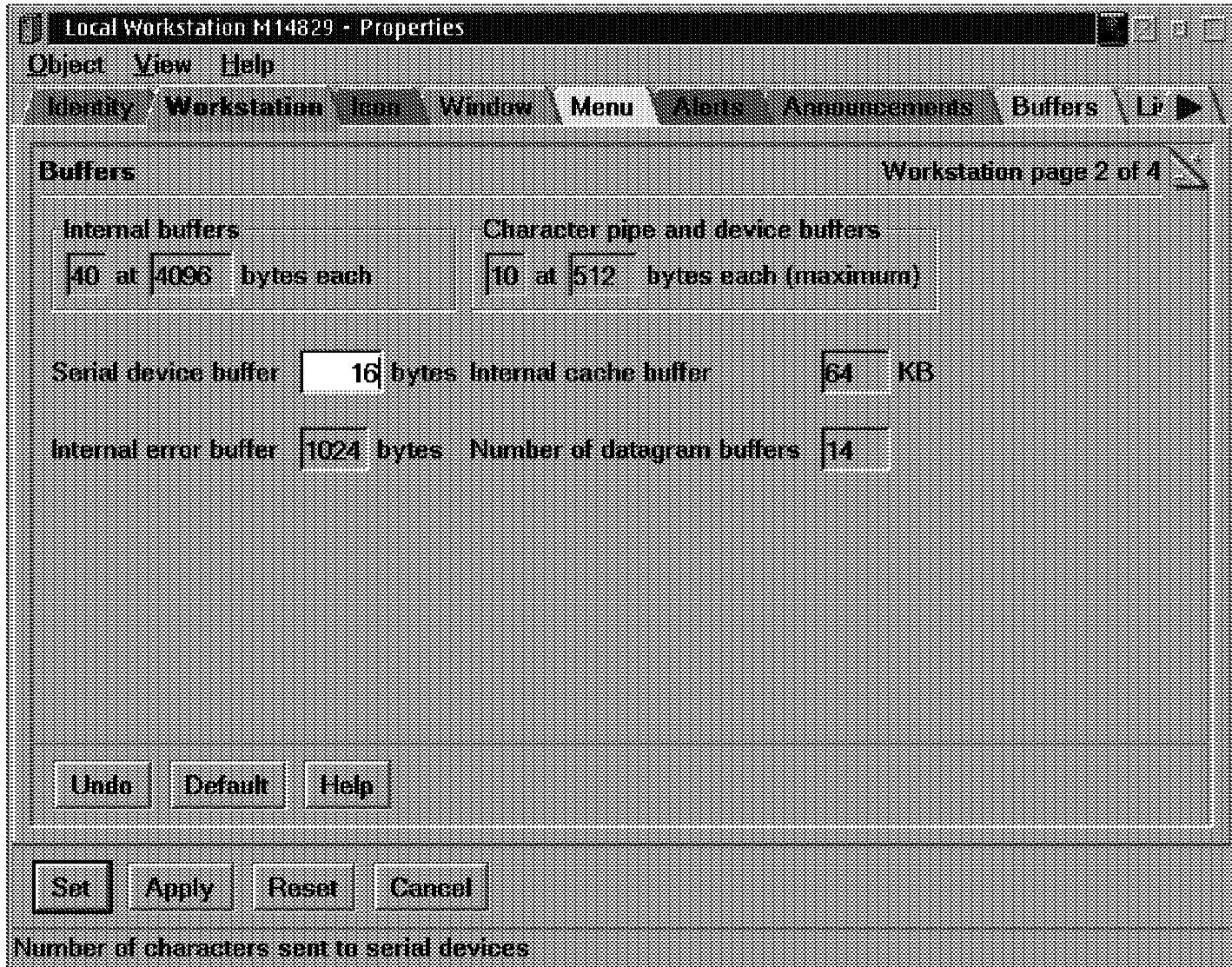

Parameters (2 of 12)

The screenshot shows a Windows-style dialog box titled "Local Workstation M14829 - Properties". The "Workstation" tab is selected. The "Limits" section contains the following parameters:

Services	16	Device driver commands	40
Threads	11	Alert message recipients	12
Size of error log	100 kilobytes		

Buttons at the bottom of the dialog include "Undo", "Default", "Help", "Set", "Apply", "Reset", and "Cancel".

Maximum size (in kilobytes) of the error log file

Parameters (3 of 12)

The screenshot shows the 'Local Workstation M14829 - Properties' dialog box, specifically the 'Workstation' tab. The 'Time-out' section is active, showing various inactivity time-out settings. The 'Send data to serial device' section has the 'After specified time' option selected with a value of 250 milliseconds. The 'Wait before closing inactive print jobs' checkbox is checked at the bottom.

Local Workstation M14829 - Properties
Object View Help

Identity Workstation Icon Window Menu Alerts Announcements Buffers Lr ▶

Time-out Workstation page 4 of 4

Inactivity time-outs

UNC connection	600	seconds
File search request	600	seconds
Session	45	seconds
Print job	90	seconds
Serial device	3600	seconds

Send data to serial device

When buffer is full

After specified time milliseconds

Undo Default Help

Set Apply Reset Cancel

Wait before closing inactive print jobs

Parameters (4 of 12)

The screenshot shows the 'Alerts' tab of the 'Local Workstation M14829 - Properties' dialog box. The 'Notification' section is active, showing the following settings:

- Alert notification interval: 5 minutes
- Alert thresholds:
 - Error log entries: 5
 - Access violations: 5
 - Logon violations: 5
 - Network I/O errors: 5
 - Free disk space: 5000 KB

Buttons at the bottom include 'Undo', 'Default', 'Help', 'Set', 'Apply', 'Reset', and 'Cancel'. A footer note reads: 'Interval for notifying users of network events'.

Parameters (5 of 12)

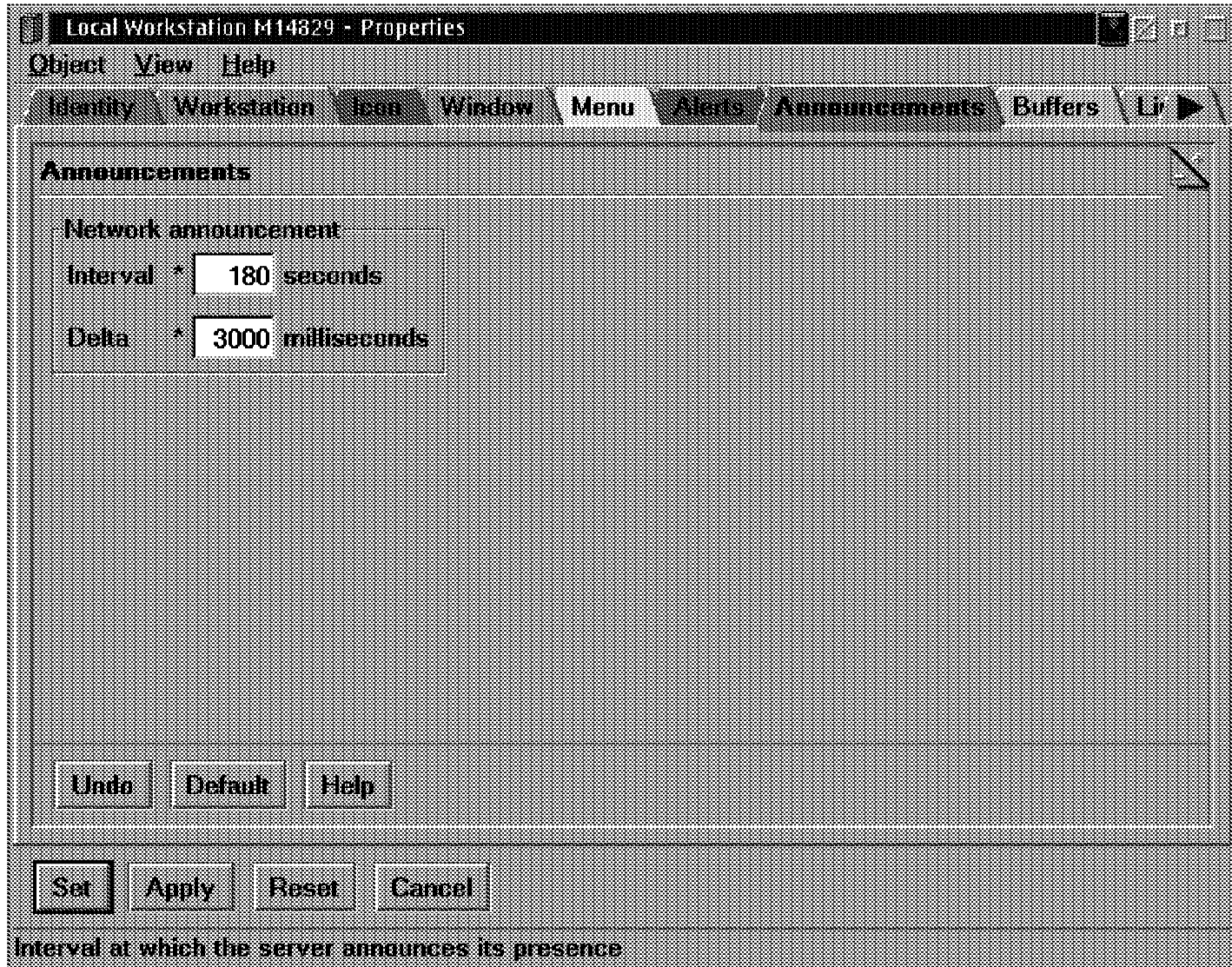

Parameters (6 or 12)

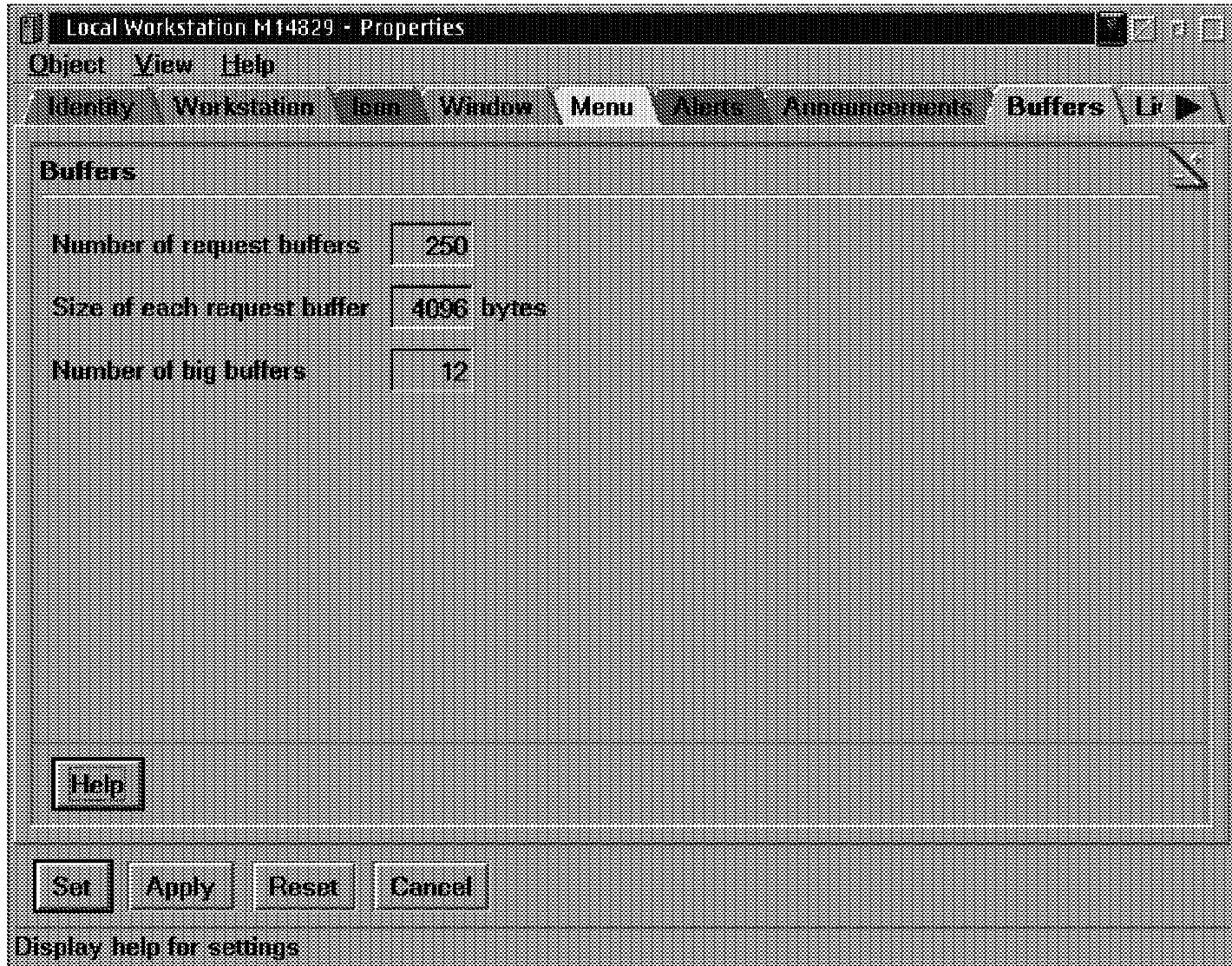

Parameters (7 of 12)

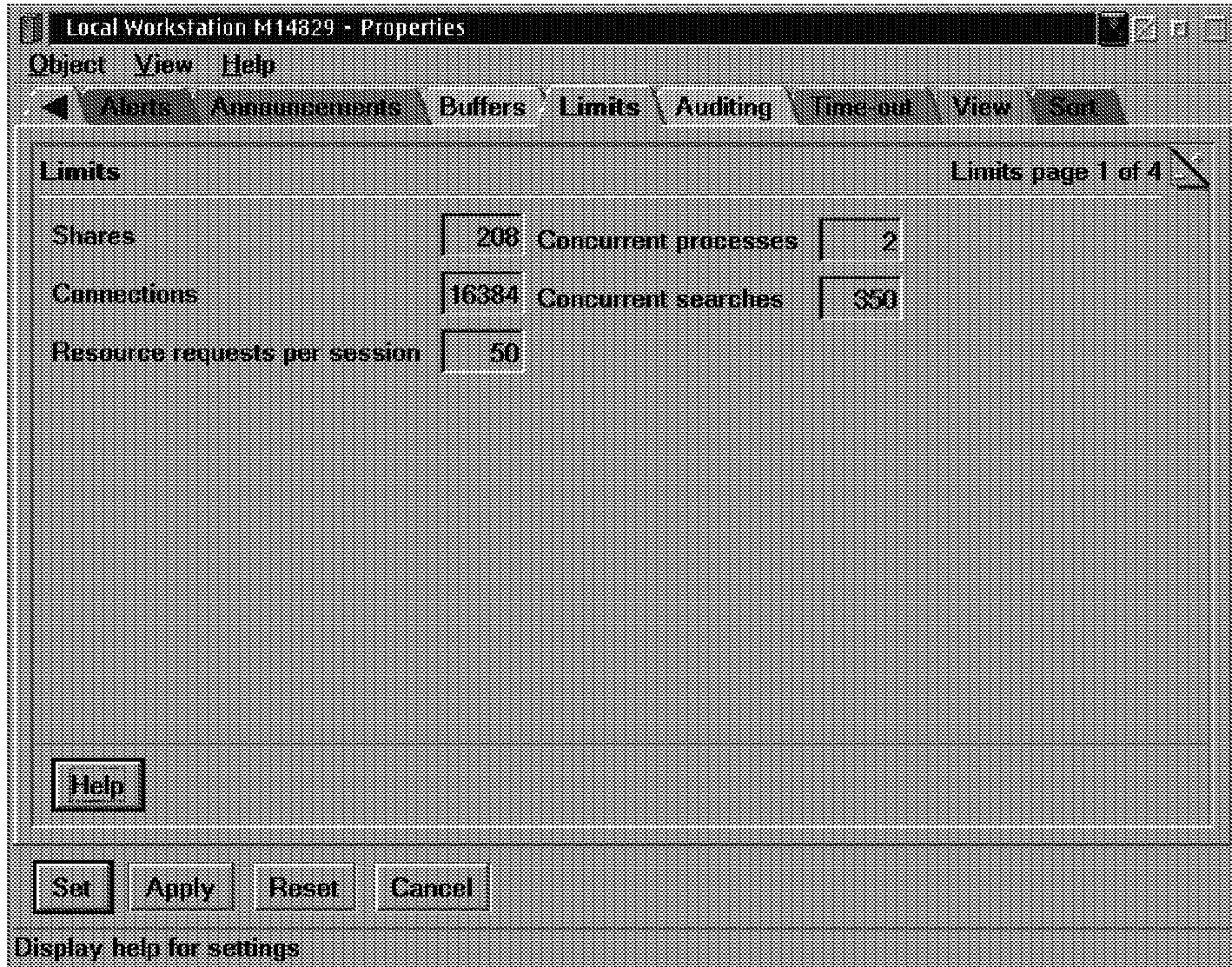

Parameters (8 of 12)

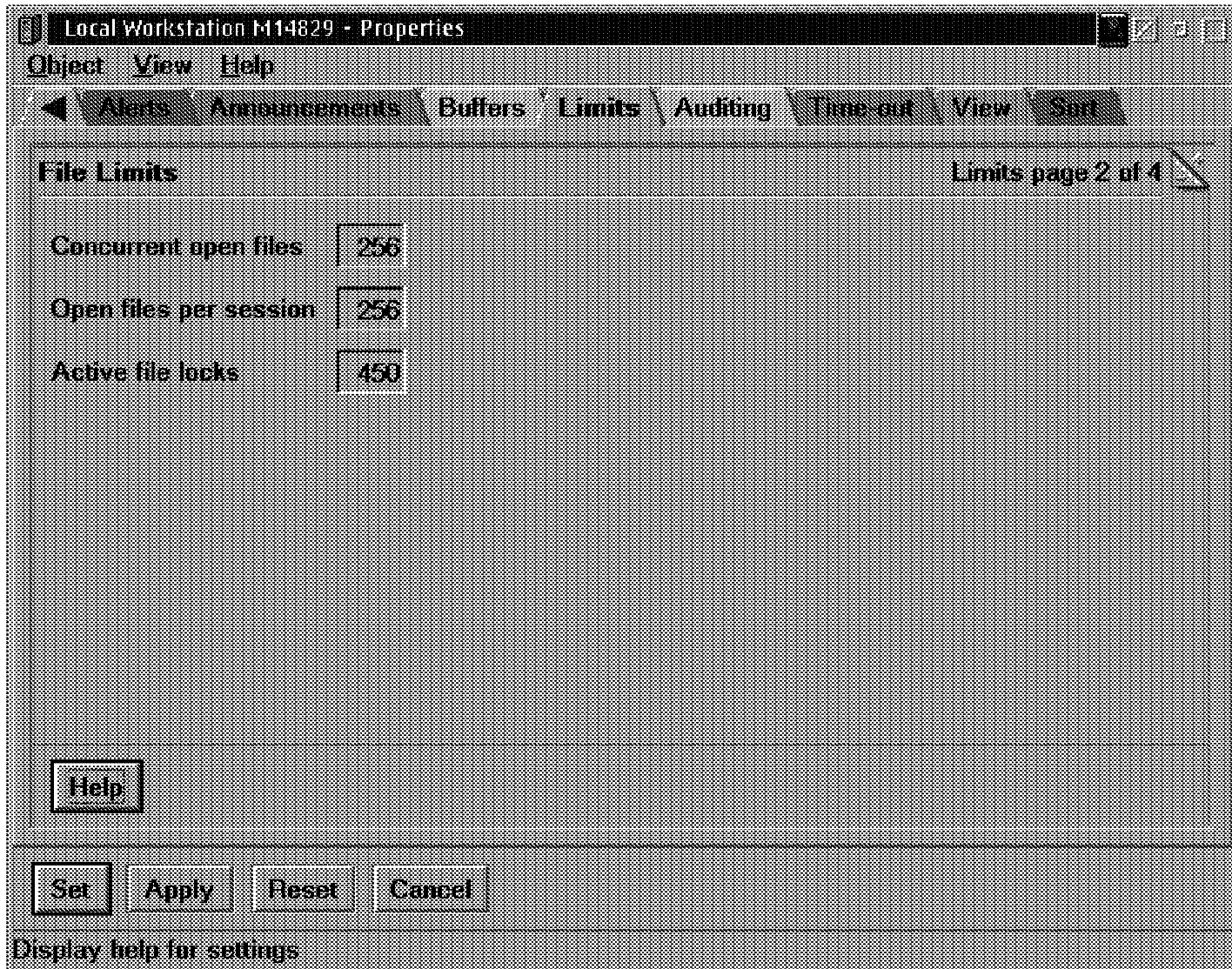

Parameters (9 of 12)

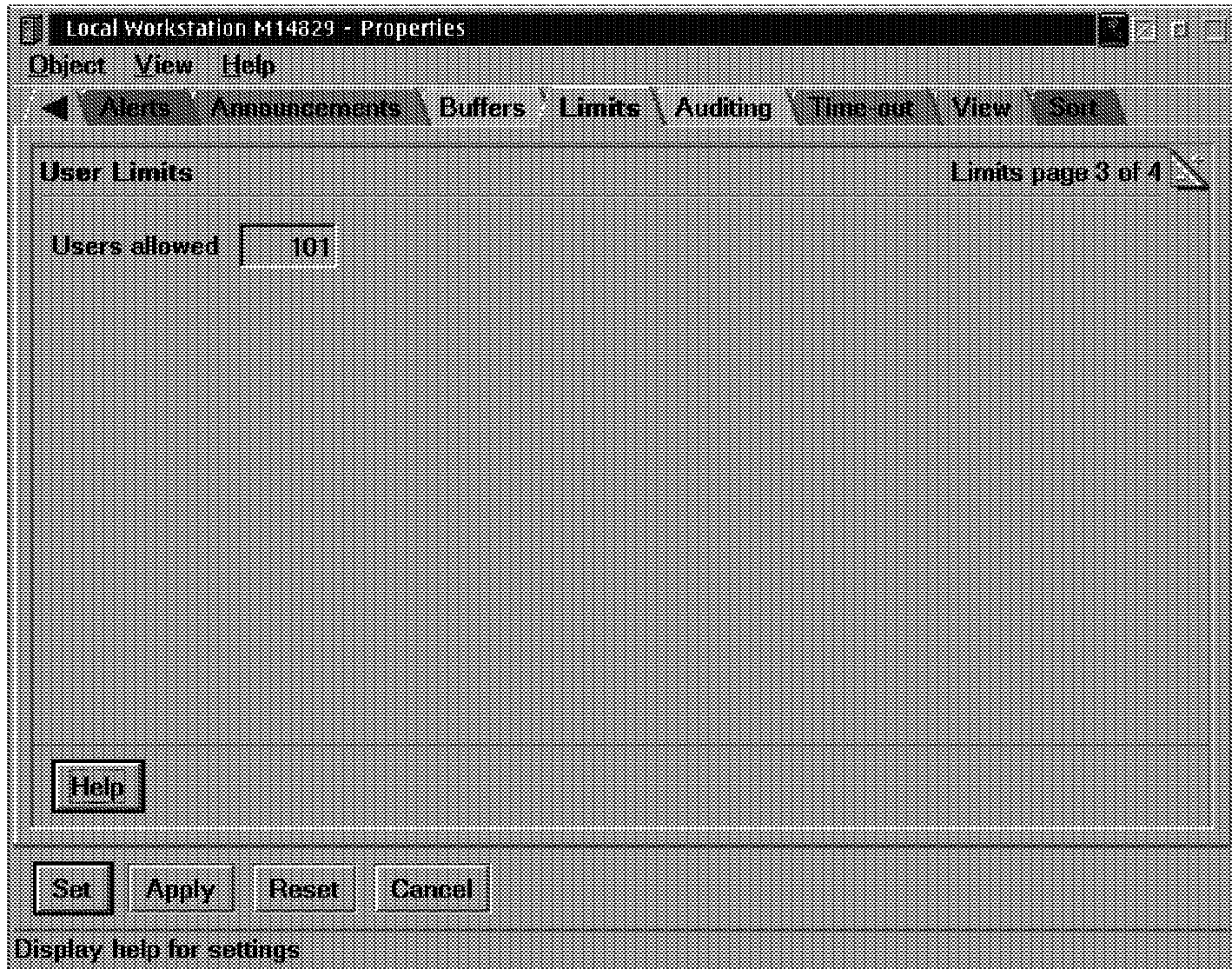

Parameters (10 of 12)

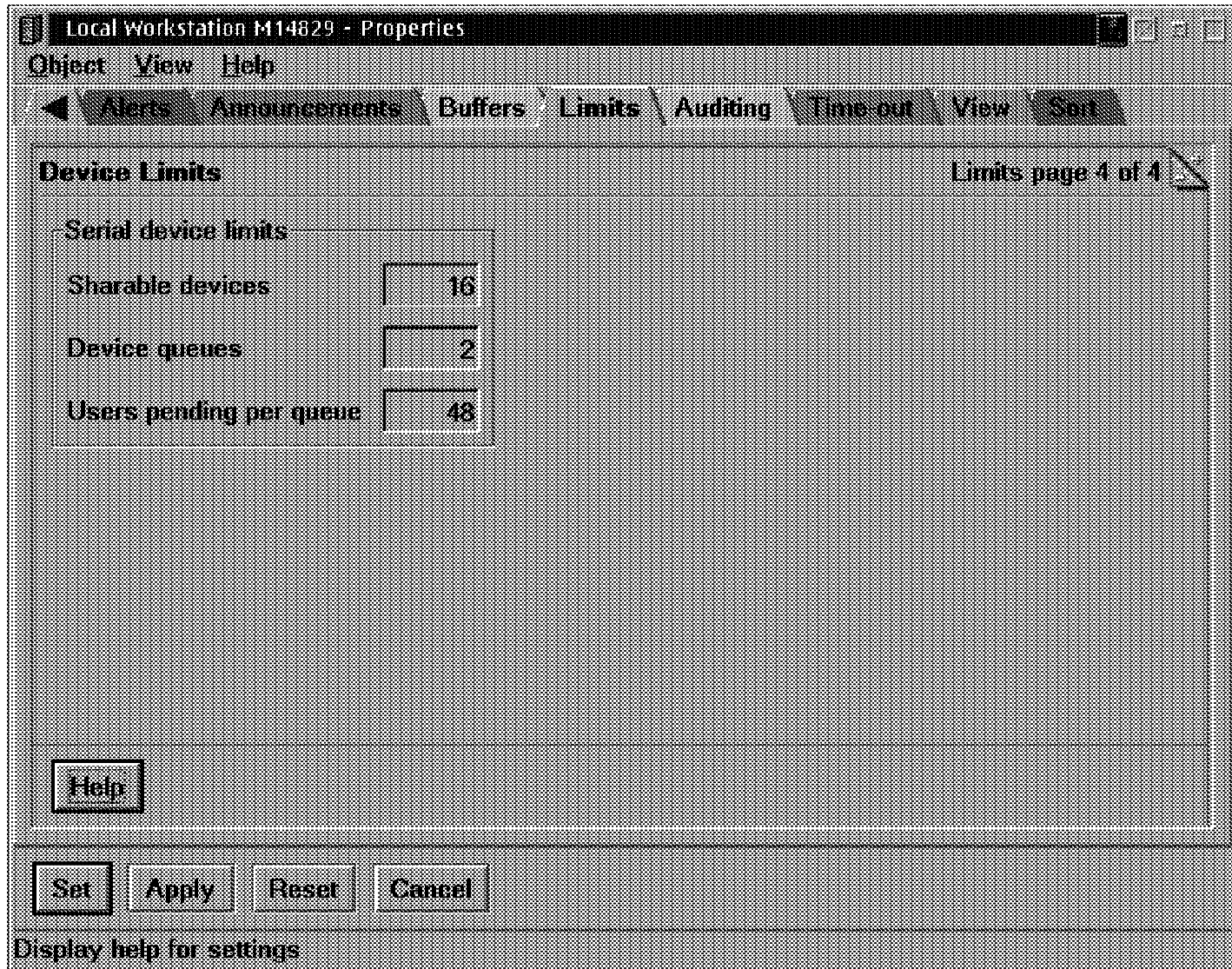

Parameters (11 of 12)

Local Workstation M14829 - Properties

Object View Help

Alerts Announcements Buffers Limits **Auditing** Time-out View Sort

Auditing

Auditing enabled

Auditable Events	Status
Service state changes	
Successful session requests	
Unsuccessful session requests	
All session requests	
Successful domain logon requests	
Unsuccessful domain logon requests	
All domain logon and logoff requests	
All domain session and logon requests	
Successful share requests	
Unsuccessful share requests	

Audit file size KB

Undo Default Help

Set Apply Reset Cancel

Maximum size in kilobytes of the audit file

Parameters (12 of 12)

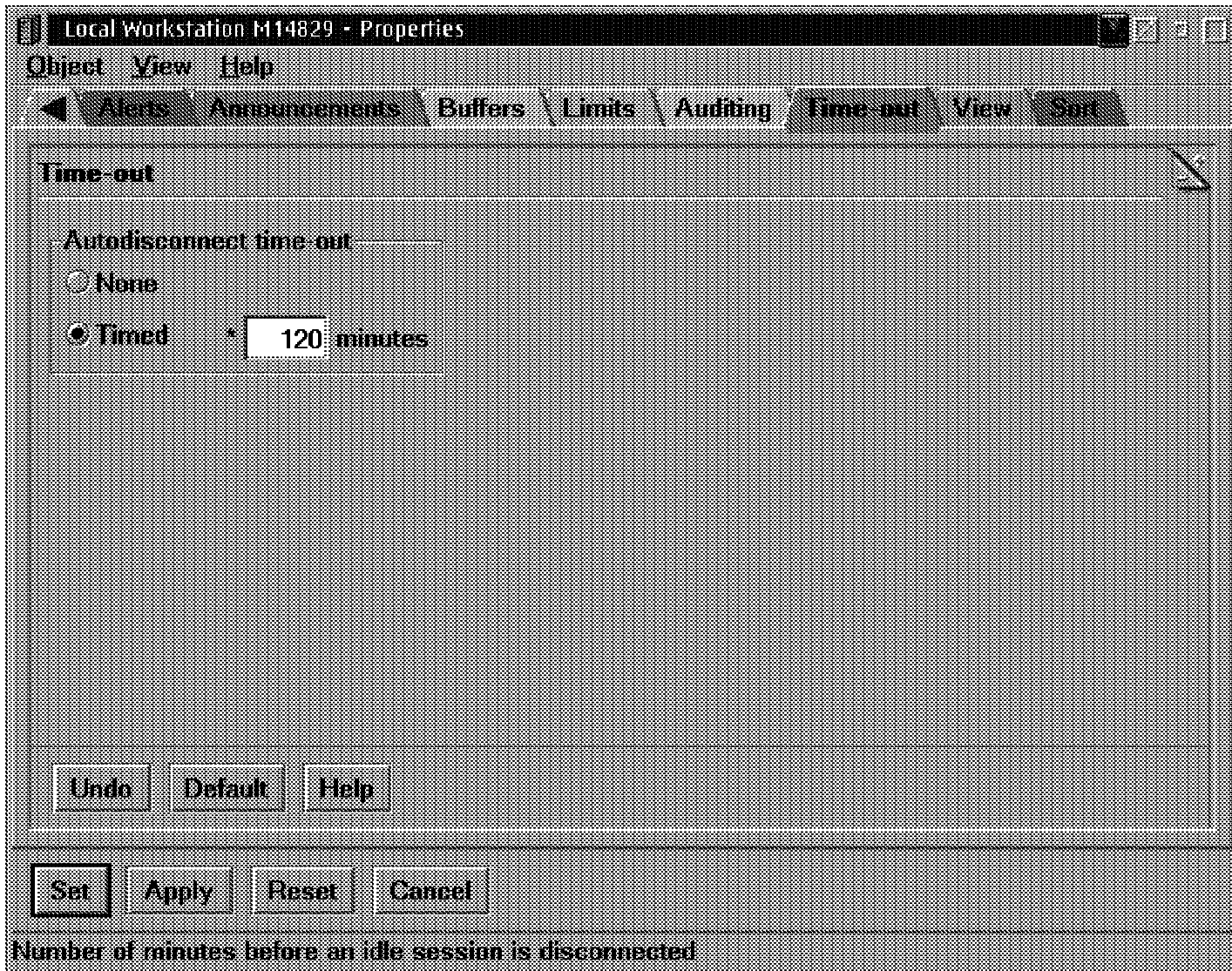

View and Close Open Files

- LAN Admin GUI
- Net File <id /C>

View and Delete Active Sessions

- LAN Admin GUI
- NET SESSION <\\machineid /delete>

Performance Statistics

- LAN Admin GUI
- NET STATISTICS

Perform Auditing Tasks

- LS Audit Log Utility
- NET AUDIT

Manage Error Logs

- LS Error Log Utility
- NET ERROR

Schedule Tasks

- Schedule tasks to run
- AT command

Configure and Use an Uninterruptible Power Supply Service

- [UPS] section IBMLAN.INI
 - batterymsg Interval of time used to repeat alerts for low battery
 - batterytime Number of seconds server can run on battery
 - cmdfile CMD file to be run before the server shuts down
 - cmdtimer Number of seconds the CMD file has to complete
 - devicename UPS_DEV
 - lowbattery WARNING/SHUTDOWN if battery power is low AC ok
 - messdelay Delay between power failure and first message sent to users
 - messtime Number of seconds between messages sent
 - recharge Minutes of recharge time for each minute of battery run
 - signals Signals available from the battery (3 digits)
 - voltlevels Voltage levels for signals

Integrate DLS/Win3.1

- Client pack CD

Integrate Win95/98 and NT Clients

- Network Neighborhood Browser service

Add NT Servers to OS/2 Warp Server Domain

- Install IBM Network Users Account Manager service on NT
- Add NT server to OS/2 Warp Server domain

Clients Supported

- OS/2 Warp 3.0
- OS/2 Warp 4.0
- DOS

Protocols Supported

- 802.2 RIPL/NetBEUI
- 802.2 RIPL/TCPBEUI
- DHCP PXE RIPL/TCPBEUI
- DHCP PXE RIPL/NetBEUI

RIPL Process

- RIPL process controlled by:
- DHCP boot files:
 - <client>.INF
 - bpcommon.ISA
 - or
 - bpcommon.MCA
 - rfcnames.lst
 - rfcbcst.lst
- RPL.MAP
- NDISDD.PRO
- .CNF boot block definition file (only 802.2 RIPL) - multiple
- File Index Table (FIT) - multiple
- Defaults are created as part of the RIPL service install, but have to be updated before (or as part of) RIPL client definition.

RPL.MAP

- Unique record for each requester
- Defines Server

CNF Files

- Referred to by RPL.MAP entries
- Defines the OS to be booted and the sequence

FIT Files

- **Maps requester file names to server file names**
- **Wild cards and prototyping allowed**
- **Machine (IPL) and User files (logon)**

NDISDD.PRO

- **NDIS Device Driver profile**
- **Maps RIPL supported Network card drivers**

RIPLINST

- Installs the common client OS on the server
- Different subdirectory per OS version
- OS/2 Warp Server for e-business not supported as RIPL client

- Unpack from diskette 7 (or CD disk7 dir)
- Target install directory always x:\IBMLAN\RPL
- Use RIPLINST from target client
- Run GETRPL immediately after each RIPLINST

Creating or Changing a Remote IPL Client

- Lan Admin GUI interface
- Drag Requester template
- Set properties

Deleting a Remote IPL Client

- LAN Admin GUI interface
- Select requester and delete

Customizing Clients

- Modify "default" files before creating clients
- Special procedures for SVGA video install
- Refer to Chapter 17 of the *Network Administrator's Guide*

REXX Support

- **RPLSETD.CMD**
 - Upgrades RIPL clients to use appropriate video driver
 - Updates RIPL client to IPL a different version of OS/2
 - Updates RIPL client to change the bus type
 - Updates RIPL client for local or remote swappath and page file
 - Updates OS/2 Warp 4 RIPL client to support TCP/IP
- **RPLSVGAI.CMD**
 - Updates server with SVGA support files

Refer to Chapter 17 of the *Network Administrator's Guide*

Unit Summary

You should now be able to:

- **Manage File and DCDB Replication**
- **Tune a OS/2 Warp Server for e-business network**
- **Perform Additional Network Task**
- **Perform Multiple Client/Server Integration**
- **Understand how to install, configure, and manage Remote IPL services**

Unit 6. Migrating an Existing System to OS/2 Warp Server for e-business

Objectives

After completing this unit, you should be able to:

- Plan for migrating an existing system to OS/2 Warp Server for e-business
- Prepare a system for migration
- Understand the issues of CID migration techniques
- Understand the steps needed for simultaneously migrating to a new hardware platform and OS/2 Warp Server for e-business
- Migrate a system using panel installation

Migration Roadmap

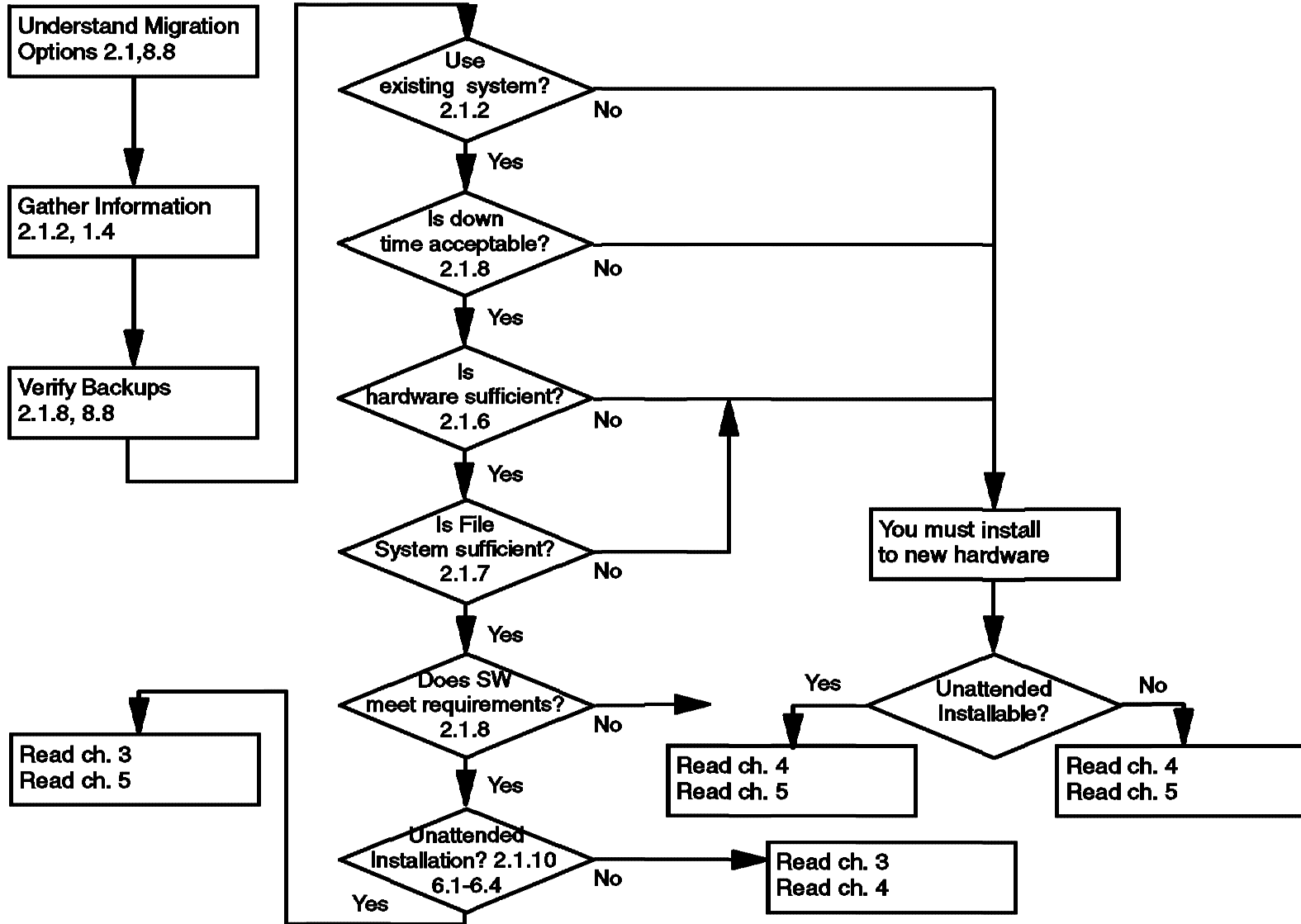

Understanding Different Options for Migration

- **Migrate 'on top' of an Existing Configuration**
- **Migrate Configuration to a New Machine**
- **Migrate to a New Machine with New Configuration**

Data Gathering (1 of 4)

Information needed	Your decision
What is the CPU speed and type?	
What amount of RAM is installed in your systems?	
How large are the handdisks in your servers?	
What are the partition size?	
How much harddisk freespace is available?	
What products and services are currently installed on each of your servers?	
Can the server be taken down for migration? How long may that period last?	
Will software distribution be used to install/migrate the servers?	

Data Gathering (2 of 4)

- Do you have a proven backup?
- Do you want to install on different hardware?
 - SMP versus UNI considerations
 - I2O support

Data Gathering (3 of 4)

Does the hardware meet the prerequisites/recommendations?

Component	Hard Disk Space Requirement (MB)
OS/2 Warp Based Operating System (default installation)	96.7
Optional OS/2 Warp Components	150
File and Print Sharing Services	15.0
TCP/IP Services	30.0
Remote Access Services	5.9
Netscape Communicator	11.0
Tivoli Management Agent	1.5
Personally Safe 'n' Sound	7.2
LDAP Services Toolkit	4.2
Advanced Print Services	54.0
MPTS	16.0
First Failure Support Technology (FFST)	0.1
Online Books	10.0

Data Gathering (4 of 4)

- Is repartitioning necessary?
- Do you want or need to change the existing file system?
 - File system and hard disk management changes
 - Drive letter sequence
- OS/2 now supports four hard disk file systems:
 - FAT
 - HPFS
 - HPFS386 (with license)
 - New JFS

File Systems

	FAT	HPFS	HPFS386	JFS
Bootable	Yes	Yes	Yes	No
Maximum Filesize	2 GB	64 GB	64 GB	2 TB
Maximum Volumesize	2 GB	2 GB	2 GB	2 TB
Disk spanning	Yes	Yes	Yes	Yes
Expand on line	No	No	No	Yes
Sparse Files	No	No	No	Yes
Unicode Filename	No	No	No	Yes
Maximum Cache size	14 MB	2 MB	ca 200 MB (320 MB- HEAP)	cs 200 MB
Max. no of file opens	65536	65536	65536	65536
Max no of file finds	3072	3072	8192	32768
ACL stored	in NET.ACC	in NET.ACC	in Filesystem (Fnode)	in Filesystem (Inode)
Number of ACLs	8192	8192	unlimited	unlimited
Max. no of file per directory	512 on the root directory	limited by DASD space	limited by DASD space	4,000,000,000
Bad block relocation	No	Yes	Yes	Yes via LVM
DASD Limits	No	No	Yes	No
Software Fault Tolerance	No	No	Yes	No

Does Your Software Meet the Requirements for Migration?

Component	CSD Level
OS/2 2.11	XR_6200
LAPS 2.20.2	WR_7045
OS/2 LAN Server 3	IP_7045
TCP/IP 2.0	UN_0000

* This is needed for compatibility with the REXX procedures in this book.

OS/2 LAN Server 3 Fixlevel prior to the Migration

Component	CSD Level
OS/2 Warp 3	XR0W038
IBM OS/2 LAN Adapter and Protocol Support	WR08415
IBM OS/2 LAN Server	IP08260
IBM TCP/IP Version 2.0	?

OS/2 LAN Server 4 Fixlevel prior to the Migration

Component	CSD Level
OS/2 Warp 3	XR0W038
IBM OS/2 LAN Adapter and Protocol Support	WRK08610
IBM OS/2 LAN Server	IP08528
IBM TCP/IP Version 3.1	UN00002

OS/2 LAN Server Fixlevel prior to the Migration

Data Gathering

- Is server downtime acceptable?
- Panel Driven Installation or CID-based?

Special Considerations/Caveats (1 of 9)

- **FDISK command not available**
- **NT coexistence on same machine**
- **Installation of OS/2 Warp Server for e-business on a machine that already has Windows NT installed will keep the data on the NT partition intact. In some configurations the pre-existing NT system might not be bootable after OS/2 Warp Server for e-business Installation.**

Special Considerations/Caveats (2 of 9)

- **Some HPFS386 features not available on JFS**
- **DASD limits**
 - **The current version of JFS shipped with OS/2 Warp Server for e-business does not support DASD limits.**
 - **Depending on your requirements there are several possible workarounds:**
 - **Keep the resources that need directory limits on a HPFS386 formatted Volume**
 - **Use CHKSTOR as a replacement if it is sufficient to send an alert to the administrator when the limit is exceeded.**
- **Fault Tolerance**
 - **There is no replacement for the HPFS386 fault tolerance feature on JFS. Current server usually has a RAID adapter that can be used to perform this function in hardware.**

Special Considerations/Caveats (3 of 9)

- Drive letters referenced in Config.SYS
- Although LVM usually can change a drive letter 'on the fly', without rebooting, your applications still might rely on the letter that was previously assigned.
 - Change all the occurrences in config.sys to the new drive and reboot.
 - Create a Script that updates the variables before starting the application.
 - If there are references in LIBPATH, use BEGINLIBPATH or ENDLIBPATH instead.
 - Move the driver to your boot drive and change the invocation in CONFIG.SYS
 - Or change only the CONFIG.SYS

Special Considerations/Caveats (4 of 9)

CD-Rom Drive letter changes requiring reboot

The RESERVEDRIVELETTER statement in config.sys can help to avoid unnecessary reboots when 'juggling' the drive letters. It can be used to force the CD-ROM to a convenient letter.

RESERVEDRIVELETTER Syntax

Add a line with

RESERVEDRIVELETTER=<letter>

anywhere in config.sys

The CD-Rom will get the next drive letter after <letter> upon the next reboot.

Special Considerations/Caveats (5 of 9)

- Naming and LVM
- LVM introduces a new level of abstraction from the underlying disk structures and allows you to name each of the elements.
 - Harddisk
 - Compability Volumes, which when bootable, should keep the same letter
 - LVM Volumes, which are not bootable and might contain multiple partitions on several physical drives
 - Partition

Element	Proposed Name
Physical Disk	IDE_0, IDE_1 or RAID_1, RAID_2 ...
Bootable Compability Volumes	WarpServer_C, SOS_D, etc.
Nonbootable Compability Volumes	Arbitrary name denoting the content
LVM Volumes	
Partition	D0P0 for Disk0 Primary0, D-P1 for disk 0 primary 1, etc, D0L0, D1L0

Special Considerations/Caveats (6 of 9)

- **NT Server integration**
 - **The IBM Network Account Manager for managing WIN NT additional servers only works with WIN NT V4.0, not with WIN NT 3.51.**
 - **The Network Account Manager relies on a Primary Domain controller with OS/2 Warp Server for e-business installed on it. This might impact the order in which you migrate your servers.**

Special Considerations/Caveats (7 of 9)

Workspace On-Demand 1.0

It is *not* recommended to install OS/2 Warp Server for e-business on a server that has Workspace On-Demand Release 1.0 installed. OS/2 WarpServer for e-business is intended to support Release 2 of Workspace On-Demand.

Special Considerations/Caveats (8 of 9)

- **Backup Software and JFS**
 - JFS supports now larger files under OS/2 than any previous OS/2 version and also has the feature to support sparse files. Make sure that your backup software can handle these features before you start to exploit them.
 - Sparse files that are backed up with software that does not support them will become 'dense' files upon restore.

Special Considerations/Caveats (9 of 9)

- Components not in the OS/2 WarpServer for e-business package

Components and Products removed by OS/2 Warp Server for e-business installation
Ultimedia Video In
OpenDoc
VoiceType
Coaches installation support
MobileFileSync
Password Coordinator
Ultimedia Mail
System View Agent
Warp 4 Tutorial
Warp 4 Hibernate and Trap Door Support (aka True Dos) support
The following Bonus Pack Utilities
Ask PSP
Hyper Access Terminal
CompuServe Info Manager
IBM Works
VideolN for OS/2
RSJ Remote Support for OS/2

Preparation Setup

Preparation Step	refer to Chapter	Check when done
Verify Fixpack Prerequisites	Chapter 4.2	
Coexistence with Windows NT	Chapter 4.3	
Perform a Test Installation	Chapter 4.4	
Evaluate Disk Utilities and Customer Written Tools	Chapter 4.5	
Have Access to Hardware Configuration Disks	Chapter 4.6	
Have Copies of Important Configuration Files Available	Chapter 4.7	
Backup your System	Chapter 4.8	
Prepare for Disaster Recovery	Chapter 4.9	
Remove LAN Distance	Chapter 4.10	
Remove Local Security	Chapter 4.11	
Back Up Directory Limits	Chapter 4.12	
Back Up Access Control Information	Chapter 4.13	
Save the DCDB	Chapter 4.14	
Remove HPFS386 Access Controls	Chapter 4.15	
Boot-Time Considerations	Chapter 4.16	
Remove IBM Peer	Chapter 4.17	
Document Printer and Queue Definitions	Chapter 4.18	
Document Multimedia Device Configuration	Chapter 4.19	
Deactivate Fault Tolerance	Chapter 4.20	

Tools for the Preparation

Preparation Step	Tools	provided by
Backup your System	SRVBU	CD
Prepare for Disaster Recovery	MAKEDISK	LAN Server
Remove Local Security	PREPACL	LAN Server
Back Up Directory Limits	BACKDASD, SRVBU	CD, CD
Back Up Access Control Information	BACKACC, LSMT, SRVBU	LAN Server, CD, CD
Save the DCDB	SRVBU	CD
Remove HPFS386 Access Controls	PREPACL	LAN Server
Document Printer and Queue Definitions	BACKPRN	CD

Perform a Test Installation

- We strongly recommend the installation of OS/2 Warp Server for e-business on a test machine prior to migrating a productive system. Try both, a pristine installation and a migration of a cloned machine for the following purposes:
 - To become familiar with the installation process
 - To discover hardware-related problems
 - To discover software related-problems concerning the migration of the operating system, OS/2 LAN Server, MPTS and TCP/IP.
 - To find out if additional programs are migrated in an acceptable manner for example, HP JetAdmin Port Driver, Lexmark Markvision Marknet Port Driver, Bonus Pack Utilities, TME 10
 - Netfinity Server 4.0 or SystemView 1.0.1
 - To discover software related problems with the JFS file system for example does your backup software handle JFS formatted drives properly?
 - To discover problems of the kind mentioned in the previous chapter "Coexistence with Windows NT"
 - To get the response files which will be created automatically by the panel-driven OS/2 installation program.

Evaluate Disk Utilities and Customer Written Tools

- WPS Issues
- File System Issues
 - As mentioned in the previous chapters OS/2 Warp Server for e-business introduces two new file system features:
 - Journaled File System (JFS)
 - Logical Volume Manager (LVM.EXE).

Configuration

- Have access to hardware configuration disks
- Have copies of important configuration files available
 - If you plan to migrate an existing machine, it may prove to be useful to have copies of the important configuration files on a diskette, because you will have to lookup some machine or user-specific data for example, MAC address, TCP/IP address and hostname, but you wouldn't be able to check it without interrupting the migration process
 - You will have to reset configuration data to its prior value, since it was modified by the installation program during the migration process . We found out that the CACHESIZE= in the HPFS386.INI file was reset to a standard value, if not configured manually. This prevented the server service from starting after the migration.

Configuration Files

File	In Directory
CONFIG.SYS	Root of Bootdrive
STARTUP.CMD	Root of Bootdrive
HPFS386.INI	\IBM386FS
PROTOCOL.INI	\IBMCOM
RFCNAMES.LST	\IBMCOM
RFCBCST.LST	\IBMCOM
IBMLAN.INI	\IBMLAN
RPL\RPL.MAP	\IBMLAN
MPTSTART.CMD	\MPTN\BIN
SETUP.CMD	\MPTN\BIN
RESOLV2	\MPTNETC
HOSTS	\MPTNETC
NAMED.BT	\MPTNETC\NAMEDB
NAMED.CA	\MPTNETC\NAMEDB
NAMED.REV	\MPTNETC\NAMEDB
SYSLOG.CNF	\MPTNETC\NAMEDB
TCPSTART.CMD	\TCPIP\BIN

Back up Your System

If for any reason you are unable to do so, you should at least have a backup of the following components (if they apply to your system):

- 1. Company's Data**
- 2. User Home Directories**
- 3. Applications**
- 4. Operating System**
- 5. User Logon Profiles**
- 6. Server Configuration Data**

The SRVBU Utility

- SRVBU is a procedure written in REXX. Running on your server, SRVBU scans a predefined set of logical drives and performs the following actions on each of the scanned drives:
 - Back up HPFS386 Access Control Information to a file DISKX.ACL, if X is the drive letter of a HPFS386 formatted partition
 1. Back up the NET.ACC to the file NETACC.BKP
 2. Back up DASD limits to a file named DISKX.DLM, if X is the drive letter of a DASD limit enabled partition
 3. Copy crucial server configuration files as specified in the SRVBU.INI file
 4. Write a disk statistics file as specified in the SRVBU.INI file
 5. Write a processing log as specified in the SRVBU.INI file
 6. Write an error log as specified in the SRVBU.INI file.

LAN Server Management Tools (LSMT)

Procedure	Purpose	output file
getusers /srv:<srvname> /m	extract user information	USERS.CSV
getgrps1 /srv:<srvname> /m	extract group names and comments	GROUPS1.CSV
getgrps2 /srv:<srvname> /m	extract groups and memberships	GROUPS2.CSV
getalias /srv:<srvname> /m	extract alias definitions	ALIAS.CSV
getacl /srv:<srvname> /m	get access profiles	ACL.CSV
getassgn /srv:<srvname> /m	get user logon assignments	ASSGN.CSV
getappl /srv:<srvname> /m	get defined public applications	APPL.CSV
getsel /srv:<srvname> /m	get application assignments	SELECTOR.CSV
getpwd /srv:<srvname> /m	get passwords (encrypted)	USERS.PWD

Prepare for Disaster Recovery

- 1. Make copies of the OS/2 installation diskettes and modify them manually**
- 2. When using HPFS386, use the MAKEDISK Utility located in \IBMLAN\NETPROG**
- 3. If your backup software offers functionality to create Disaster Recovery Diskettes, then do it this way.**
 - Verify that the Disaster Recovery Diskettes at least contain the following additional drivers, and if not, add them manually:**
 - HPFS386 driver, if your server has HPFS386 installed**
 - SCSI driver, if your backup device is a SCSI device**
 - RAID driver, if your server has a raid array**
 - backup device dependent driver.**

Remove Remote Access Services

- **The OS/2 Warp Server for e-business software cannot be installed over a previously installed Remote Access Connection Server or Remote Access Client. You must remove it before installing any OS/2 Warp Server for e-business software.**
 - **If not already part of your regular backup, save your \CONFIG.SYS and your \IBMCOM\PROTOCOL.INI to a save place.**
 - **Call LDREMOVE.EXE which is located in the Remote Access installation directory (\WAL by default).**

Remove Local Security

If you are using Local Security on at least one of the HPFS386 formatted partitions, you must deactivate it before migrating to OS/2 Warp Server for e-business by doing the following:

1. In the CONFIG.SYS file change the line
PROTSHELL=C:\IBMLAN\NETPROG\SECURESH.EXE
C:\OS2\PMSHELL.EXE
to
C:\IBMLAN\NETPROG\SECURESH.EXE
to get rid of the local logon procedure
2. Run the PREPACL utility to remove the access control information supplied by Local Security. Chapter 4.15 Remove HPFS386 Access Controls describes how to use PREPACL.

Back Up Directory Limits

- Directory limits provide disk space management at the server's directory level. If you applied directory limits to your server's file system, save them and disable them afterwards. If it is not already a part of your regular backup (for example, with the SRVBU utility), keep the saved directory limit information in a safe place for restore purposes.
- BACKDASD Example:
 - BACKDASD /F:DISK_F.DLM /P:F:\HOMEDIR

Back Up Access Control Information

- ACKACC performs the following tasks:
 1. Copies the NET.ACC file
 2. Copies the NET.AUD file
 3. Backs up Access Control Profiles for each drive to be converted to or from HPFS386
 4. Deletes access control profiles for nonexistent directories
- BACKACC Syntax
 - BACKACC d:pathname /F:target /S

Save The DCDB

- The Domain Controller Database (DCDB) is located on the domain controller containing information about definitions of network resources that users might access. Included in the DCDB are user's automatic logon assignments, public applications definitions and the details of resources shared through aliases.
 - Manual Backup
 - Replication to a Backup Domain Controller (BDC)
 - Backup With LSMT

Remove HPFS386 Access Controls

- The PREPACL utility backs up, removes, and, after the migration, restores all HPFS386 Access Control Profiles applied to any subdirectories or files specified as a parameter. Be careful, since PREPACL removes the ACLs and copies backup information to an ASCII file. Careless repetitive usage of this utility will overwrite previous file contents, and the ACLs will be completely lost.
- PREPACL Syntax
 - PREPACL /P /B:filename /D:dirname

Boot-Time Considerations

- The following actions are not necessary, but can avoid problems and shorten installation time:
 - Remark all device drivers in the CONFIG.SYS which are not necessarily needed for the migration
 - Remark all programs in the STARTUP.CMD which are not necessarily needed for the migration
 - Remove the icons of all the programs from the startup folder which are not necessarily needed for the migration.
- Don't forget to undo these changes after the migration.

Deactivate Fault Tolerance

If you are running OS/2 LAN Server Fault Tolerance, unmirror and deactivate all those currently mirrored drives on which services will be installed.

Partition	Driveletter	Size	Partition Type	Filesystem
(BOOT MANAGER)	N/A	(depends on HD)	primary	N/A
SoS	C:	32 MB	primary	FAT
System	D:	512 MB	logical	HPFS or HPFS386
Dump	E:	RAM size + 1 MB	logical	FAT
Data	F:	(optional)	logical	JFS
CD-Rom	G:	N/A	N/A	CDFS

Preparation

- Document Multimedia Device Configuration
- Remove IBM Peer
- Document Printer and Queue Definitions
 - If you have defined printer queues on your server, manually recording all the printer and queue definitions is a tedious task. We used the tool BACKPRN, which backs up printer and job properties to a file. This file can be used later for restoration by RESTPRN or RINSTPRN (the remote printer installation program

Preparing the Migration

- General Structure of the Server's Disks
- Backup Domain Controller
- Migrating the File and Print Servers
- Migrating the Primary Domain Controller

Performing the Migration

- Preparing the system
 - Select the install volume
 - Format the volume (if necessary. In our case we will obviously not format the volume)
 - Copy the system files
 - Configuring hardware and software options
 - Installing and configuring the server components
- Copying the needed files
- Installing the LAN server components

Under the Covers

- The installation process is a three phase one (each of these phases is separated from the other by a reboot).
- Phase 1
 - This phase uses the text-based interface and during it, the files needed to restart the operating system from the hard disk are copied. In details, the CDBOOT.EXE program is started and under its control CONINST.EXE (CD-ROM and Network adapter card detection) and SYSINST2.EXE (Installation type query, FDISK Call, Actual files copy) are run.
- Phase 2
 - During this phase, the rest of the operating system and the selected other components are installed including MPTS (Multi Protocol Transfer Services)
- Phase 3
 - The last phase is used to install TCP/IP and the LAN Server components. The last objects are created and placed in their respective folders. It is followed by the last reboot that will bring up the default desktop.

Finishing the Migration

- When all the Base OS/2 system and LAN Server components have been installed, there is still some work to do:
 - If you migrated a Backup Domain Controller, verify that all its functions are correctly restored (Use for example here also the LSC.cmd and LSDCDB.Cmd programs). If you migrate a BDC, be sure you consider the need to (switch roles with the PDC).
 - If you migrated a File and Print Servers, check also that the aliases and the shares have effectively be restored.
 - If you migrated your Primary Domain Controller, then check that everything is now in place and that your general user can access the network and all the files he used.

Migration Methodology

The basic steps in this process are as follows:

1. Prepare the new hardware
2. Test the new hardware to ensure that the system is functioning properly
3. Backup existing system configuration
4. Backup system data
5. Install OS/2 Warp Server for e-business on new hardware
6. Restore existing configuration to new hardware
7. Restore existing data to new hardware
8. Perform post-installation procedures
9. Perform integration procedures

Preparing New Hardware

Depending on the model/type, size and complexity of the new hardware, the amount of effort required to prepare the hardware in advance will vary. The preparation may include locating the correct system support diskettes, adapter drivers, peripheral drivers and actually configuring the new hardware itself. Specific preparation details will not be discussed here.

Please verify that your hardware is supported before you proceed.

Supported Hardware

You will be able to find most current information on supported hardware on the Internet. Please see the following address:

<http://www.software.ibm.com/os/warp/support>

Additional device support is available at the following address:

<http://service.software.ibm.com/os2ddpak/index.htm>

Testing

Before any system is integrated into a business environment, it should be fully tested. As a minimum, we recommend the following test procedure:

1. Install OS/2 Warp Server for e-business on new hardware
2. Perform system testing
3. Perform functional testing
4. Develop migration plan
5. Test migration plan
6. Test recovery procedures

When preparing new hardware, you have the existing system available until the new hardware is brought online. You will only need to do the recovery procedures if something goes wrong after the new system is online.

Suggested Hardware

Since some migration scenarios rely on moving to alternative hardware, part of the migration will involve deciding what hardware to implement. This is a decision which will be different depending on the environment for which the system is needed.

NOTE: We recommend that you undertake detailed performance and capacity planning when deciding what hardware to implement.

Backup and Contingency

Do not place your business at risk, please make sure that you have a reliable backup and recovery strategy in place.

The recommended steps in this process are:

- 1. System backup**
- 2. Data backup**
- 3. Configuration backup**
- 4. Proven recovery procedures**
- 5. Migration strategy**

Migration Strategy

Items to consider:

1. Install the new system in a test environment and then swap out the existing system ?
2. Are both machines (the existing and the new machine) both online during the migration? Would you rename the new machine when migration is complete?
3. Any others?

Installation

Items to consider:

1. The migration can be either "simple" or "complex". Please refer to Chapter 5 for "Simple Migration" and Chapter 6 for "Complex Migration".
2. Installation to a new machine...(may need to backup and restore data/configuration from an existing server).

Preparing the CID Installation

- Establish a code server
 - LAN CID Utility (LCU) - Comes with OS/2 Warp Server
 - SRVIFS - Comes with MPTS
 - NetViewDM/2
- Copy images to the code server

```
xcopy d:\OS2IMAGE x:\CID\IMG\OS2\ /s /e
xcopy d:\CID\DLL x:\CID\DLL\ /s /e
xcopy d:\CID\EXE x:\CID\EXE\ /s /e
xcopy d:\CID\LOCINSTU x:\CID\LOCINSTU\ /s /e
xcopy d:\CID\NIFS x:\CID\NIFS\ /s /e
xcopy d:\CID\SERVER x:\CID\IMG\ /s /e
```

The Installation Steps

- Preparation Steps
 - Do all the preparation steps to ensure a fail-safe migration process
 - Exception: don't remove the ACLs on HPFS386
- Create a maintenance system
 - Run SEMAINT
 - Run THIN386 - If you are using HPFS386
- Update the Base Operating System

Principles of CID

- CID Enablement
- CID for Migration
- Response Files
- Redirected Drives
- Code Servers

LCU Server

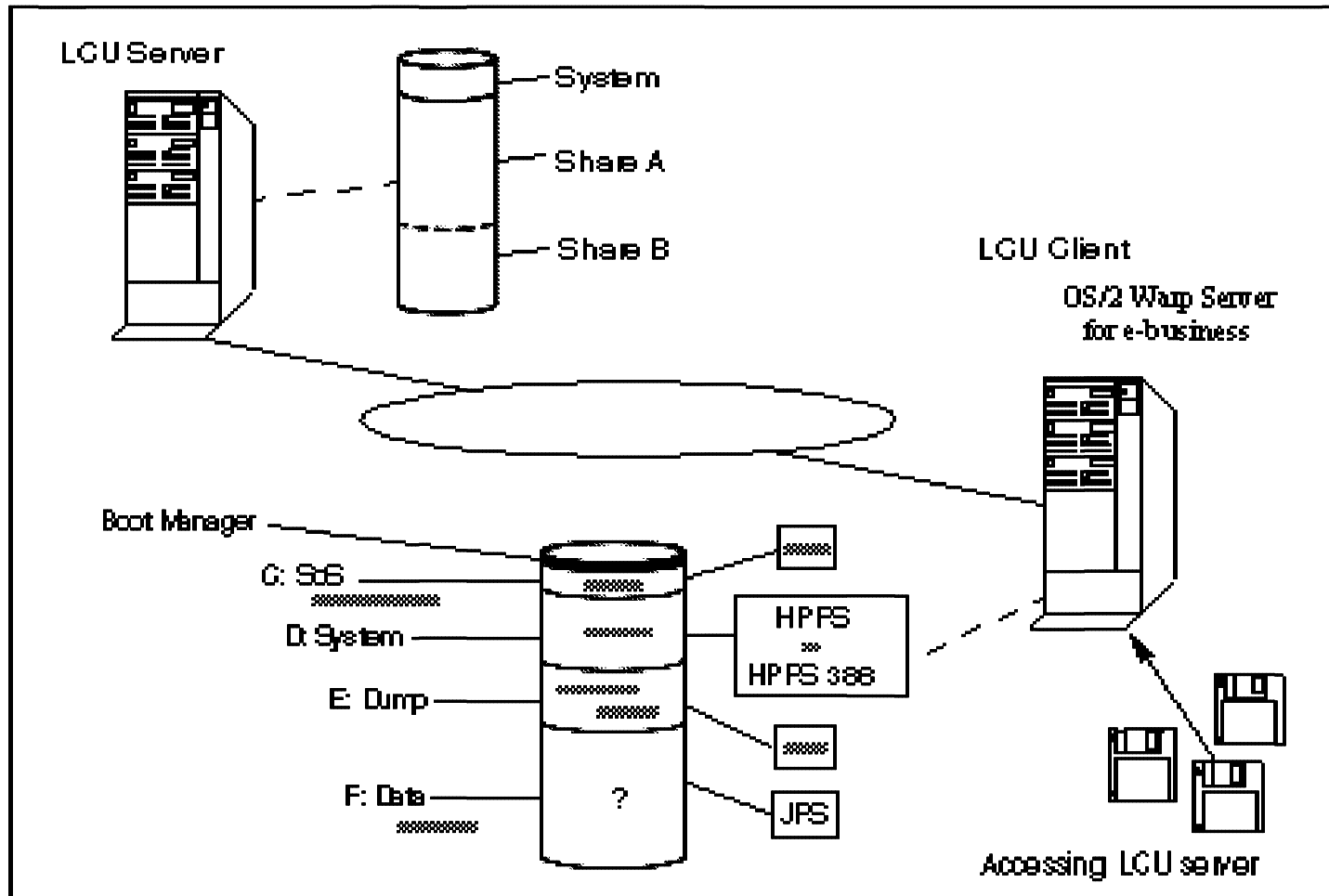

Setting Up a LCU Code Server

- As already mentioned, you need an OS/2 server with a large amount of free disk space to hold the LCU directory structure (cfr. See LCU server : directory structure).
 - Create all the subdirectories (\ShareA, \ShareB, \ShareA\IMG, ...)
 - Then you should copy the images of the products into \ShareA\IMG.
 - Afterwards, you should configure the LCU server, and start running it.
 - Copy the product images to the IMG directory
 - First of all, we have to copy the images of all products from the different CD-ROM's to the \ShareA\IMG directory of the code server.

LAN CID Utility

- **A simple and powerful tool called LAN CID Utility (LCU) ships as part of Multiple Protocol Transport Services (MPTS) - included in OS/2 Warp Server for e-business.**
- **As far as networking and software distribution is concerned, MPTS consists of three primary components:**
 - **Adapter and Protocol Services**
 - **LAN CID Utility (LCU) and Code Server SetupUtility(CASSETUP)**
 - **SrvIFS (Server Installable File System)**

Software Distribution Managers

In this Unit, we consider the following types of code server:

LAN CID Utility (LCU)

NetView Distribution Manager/2 (NVDM/2)

Tivoli TME 10 SD 3.1.3 (SD4OS2)

Assumptions

- **Pristine Installation**
 - In spite of the fact that we are considering a migration scenario, the installation of new products which come with OS/2 Warp Server for e-business has been discussed here. However, we emphasize that it is not a specific part of this migration scenario.
 - New product installation scenarios are described fully in a forthcoming red book "Inside OS/2 Warp Server for e-business" (SG24-5136-00), due in the first half of 1999.
- **CID Knowledge**
 - Throughout this unit, we assume a basic knowledge of CID techniques. We believe that many of the existing enterprise customers already use either CID, NVDM/2 or SWD products.

Preparing the Code Server

- **Installing and Tailoring the Code Server**
- **The code server set up consists of the following broad steps:**
 - **Create the appropriate CID directory structure**
 - **Load OS/2 CID utilities to the code server**
 - **Load product images to server**
 - **Create response files for each installable product**
 - **Set up the software distribution manager, if applicable**

Preparing the Code Server

- Preparing the Code Server
- Creating Response Files
- Introducing Feature Installer
 - 386HPFS
 - Java Development Kit (including Java Runtime Environment - JRE)
 - OS/2 Printer Utilities (HP JetAdmin and Lexmark MarkNet)
 - Personally Safe N' Sound
 - Lightweight Directory Access Protocol (LDAP) Client Toolkit
 - TCP/IP Applications
- Introducing Software Installer
 - Some products are still installed by the Software Installer program.
 - Lotus Domino Go Webserver 4.6.2.5
 - Netscape Communicator 4.04
 - Tivoli Management Agent: TME Endpoint 4.0

Overview of Installation Steps

Note on Installation Order

We have tried to highlight inter-dependencies between individual product installation steps, but it is impossible to guarantee that in your environment you will not encounter additional issues. Therefore we repeat our advice that you fully test your CID environment prior to actually migrating a production system!

Preparation Phase

Create Maintenance System (SEMAINT)

Logical Volume Manager (LVM) Issues

Seed LAN Transport (THINLAPS)

File System Redirection (THINIFS)

Access to 386 HPFS Volumes (THIN386)

LCU Installation (CASINSTL)

Base OS/2 Installation - Phase One

- Install Base OS/2 Operating System (SEINST)
- Multiprotocol Transport Services (MPTS)

Installation - Phase Two

- Display Driver Install (DSPINSTL)
- OS/2 Feature Installer (CLIFI)

Principle Applications

- File and Print Sharing Services (LANINSTR)
- 386 HPFS (CLIFI)
- First Failure Support Technology/2 (FFSTINST)
- TCP/IP Application Services (CLIFI)
- Netscape Communicator (INSTALL)

Other OS/2 Warp Server Applications

- **Personally Safe N' Sound (CLIFI)**
- **Remote Access Services (or PPP Server) (INSTALL)**
- **Print Services Facility/2 (PSF2)**
- **OS/2 Warp Server for e-business Books (INSTBOOK)**

New Applications

- **Netfinity Services (NETFINST)**
- **Lightweight Directory Access Protocol (LDAP) (CLIFI)**
- **Tivoli Management Agent (INSTALL)**
- **Lotus Domino Go Webserver (INSTALL)**
- **Websphere Application Server (WEBSPHER)**

Final Phase - Clean Up

- Delete SrvIFS (IFSDEL)
- Delete LCU (CASDELET)

CID Installation Parameters

- **Create LCU Boot Diskettes**
 - In a pristine installation, it is necessary to create LCU boot diskettes for the system which will be installed. This is not necessary in a migration scenario.
 1. **Create Original Boot Diskettes from CD ROM images**
 2. **Add LAN Transport and Adapter Support to the diskettes**
 3. **Add LCU Client Support to the diskettes**
 4. **Create a Startup Script**
 5. **Clean up the CONFIG.SYS on DISK 1**
 6. **Make Disk 2 unbootable using DBOOT**

- **When you have prepared your code server you will be ready to boot with client diskettes and start your pristine installation.**

Create Maintenance System (SEMAINT)

- SEMAINT creates a maintenance system on your bootable partition, or on another partition which will be booted in order to install OS/2. It copies a minimal version of the operating system to a new directory on a designated drive. When booted from the maintenance system, only text-mode programs can run.
- SEMAINT Syntax
 - SEMAINT /S:<Source_Path> /S2:<Service_Pak>
/T:<Target_Path> /B:<Boot_Drive>
/L1:<Path><Log_File_Name>

386 HPFS File System Access (THIN386)

- In the past, if you were using 386 HPFS formatted drives, THIN386 had to be run. THIN386 installs the 386 HPFS file system drivers onto the maintenance system, which ensured that the installation process had unrestricted access to all server drives.
- This step is not needed with OS/2 Warp Server for e-business. We have found that this step is no longer required if access controls are removed from the file system prior to the migration using PREPACL.

Logical Volume Manager (LVM) Issues

- OS/2's FDISK utility has been replaced by the Logical Volume Manager (LVM). During migration the existing partitions must be converted to LVM Compatibility Volumes.
- At the time of writing, we had to implement a workaround so that the installation completed unattended.
- In a pristine environment, the disk must be partitioned via command line procedures automatically. The old FDISK command line switches no longer apply and new methods must be used.

Install Base OS/2 Operating System (SEINST)

- Once the machine has been booted from the maintenance system, SEINST can be called to start the first phase of installation of the base OS/2 operating system.
- SEINST Syntax\
 - SEINST /S:<Source_Path> /T:<Target_Path>
/B:<Boot_Drive> /L1:<Log_File> /R:<Response_File>

Multiprotocol Transport Services (MPTS)

- The easiest way to upgrade MPTS is to re-install it using the same values in the response file that were specified during the last installation. Installing - or rather updating - MPTS immediately following the migration of the base OS/2 operating system saves one reboot in the overall installation cycle.
- During our testing, we found no significant changes in the way MPTS is installed compared to previous versions.
- MPTS CID Installation Syntax
 - MPTS /E:<env> /S:<source_path> /T:<target_path>
/TU:<config_path> /R:<response_file> /L1:<log_file>

File System Redirection (THINIFS)

- The SrvIFS (Server Installable File System) provides an easy means of redirection. THINIFS installs the necessary SRVIFS redirection files on the hard disk.
- We execute THINIFS twice to obtain two redirected drives for the next part of the installation, having rebooted to Presentation Manager mode.
- THINIFS Syntax
 - THINIFS /S:<Source_Path> /T:<Target_Path>
/SRV:<CodeServer_Name> /REQ:<Client_Name>
/D:<Drive_Letter> /TU:<ConfigSys_Path>
/L1:<LogFile_Name> /NS:<NB_Sessions>
/A:<IFS_Option> /W

LCU Installation (CASINSTL)

- CASINSTL installs the LAN CID utility client code, which is the actual software distribution manager that works with SRVIFS.
- CASINSTL Syntax
 - CASINSTL /TU:<Boot_Drive> /CMD:<LCU_Path> /D /D:<Default_CMDFile> /L1<LogFile> /L2<LogFile2> /PL:<Path_Values> /PA:<LCU_Path> /PD /REQ:<Client_Name> /0

Installation - Phase One (1 of 6)

- **Display Driver Install**
 - If you need to have a better resolution and/or more colors than the default 640x480x16 setup, you should install the appropriate display driver. For example Netscape Communicator at the time of writing - needs at least 256 colors to run.
- **Feature Installer**
 - As previously mentioned, some components that belong to the base OS/2 operating system are installed by Feature Installer. After the initial installation using SEINST and following a reboot, Presentation Manager is working. With this pre-requisite fulfilled, CLIFI.EXE can be used to complete the update.

Installation - Phase One (2 of 6)

- **File and Print Sharing Services**
 - The most important difference between this and the previous versions of LAN or Warp Server is that LANINSTR (the File and Print Sharing Services installation program) no longer installs 386 HPFS. However, the parameters of LANINSTR remain unchanged.
- **386HPFS**
 - Because 386HPFS is now shipped as a separate product, it is no longer installed by LANINSTR. Moreover, LANINSTR will remove any 386 HPFS drivers from the disk drive. If you are installing 386HPFS for the first time, make sure that you install it after File and Print Sharing Services, but before rebooting the machine the next time it is needed.
- **First Failure Support Technology (FFST/2)**
 - In a CID environment, FFST/2 has to be installed in a separate step. The installation program is called FFSTINST.EXE.

Installation - Phase One (3 of 6)

- **TCP/IP Application Services**
 - Previous versions of TCP/IP used INSTALL.EXE for installation. From version 4 onwards, there was a switch to Feature Installer. The procedures and response file we have provided represents a working version and uses Feature Installer.
- **Netscape Communicator**
 - Netscape Communicator is installed using Software Installer. The basic product is installed by the installation program INSTALL.EXE in the \CID\SERVER\NETSCAPE directory on the OS/2 Warp Server for e-business CD ROM).
- **Personally Safe N' Sound (PSNS)**
 - Like many other products, Personally Safe N' Sound is installed by the Feature Installer.

Installation - Phase One (4 of 6)

- **Remote Access Services (RAS) or PPP Server**
 - Remote Access Services (also known as PPP Server) replaces the LAN Distance product. LAN Distance must be removed with the LDREMOVE command prior to installation of Remote Access Services.
- **Print Services Facility**
 - We have had to implement a two-stage installation of PSF/2. We implement these two steps in one command file - PSF2PREP.CMD. This procedure first copies the source files to a local drive. It then calls the INSTALL through the LCU batch procedure.
- **Netfinity Services**
 - For further information on the installation of Netfinity Services, refer to the separate Netfinity Services CD that came with the OS/2 Warp Server for e-business package.

Installation - Phase One (5 of 6)

- **Lightweight Directory Access Protocol (LDAP) Client Toolkit**
 - OS/2 Warp Server for e-business supports Lightweight Directory Access Protocol (LDAP), and the product contains a client toolkit which may be installed. It is installed using Feature Installer. For further information on the LDAP client toolkit please refer to the online documentation and the \CID\SERVER\LDAP directory on the OS/2 Warp Server for e-business
- **Tivoli Management Agent (TMA)**
 - For further detail on the installation of the Tivoli Management Agent, refer to the online documentation and the \CID\SERVER\LCFAGENT directory on the OS/2 Warp Server for e-business CD ROM.
- **Lotus Domino GO Webserver**
 - OS/2 Warp Server for e-business includes a fully functional trial version of Lotus Domino Go Webserver. Lotus Domino Go Webserver is installed using Software Installer.

Installation - Phase One (6 of 6)

- **Websphere Application Server**
 - We found that the installation of WebSphere was not entirely CID enabled. In order to achieve successful unattended installation, we created a REXX command file **WEBSPHER.CMD**. This command file is shipped on the CD ROM with this book.
- **OS/2 Warp Server Books**
 - If they must be installed, then they can be by a REXX script called **INSTBOOK.CMD**, located in the **\IBMINST** directory on the OS/2 Warp Server for e-business CD-ROM.
- **IFSDEL**
 - IFSDEL removes the files installed by THINIFS.
- **CASDELET**
 - CASDELET removes all trace of LCU from the system. It is executed after all products have been installed.

Unit Summary

You should now be able to:

- Plan for migrating an existing system to OS/2 Warp Server for e-business
- Prepare a system for migration
- Understand the issues of CID migration techniques
- Understand the steps needed for simultaneously migrating to a new hardware platform and OS/2 Warp Server for e-business
- Migrate a system using panel install

Unit 7. Resolving Problems

Objectives

After completing this unit, you should be able to:

- Identify locations and purposes of various log files
- Identify references for various messages
- Analyze logs and messages to identify components related to the failure
- Disable autostart of server components and manually start each component in the proper sequence
- Resynchronize server passwords between Domain Controller (DC), backup DC and additional servers
- Identify appropriate support assistance (application, IBM, vendor, hardware, and so forth) and use proper channels to invoke that support
- Understand the purpose and setup requirements of system problem determination (PD) data gathering tools that may be required by support
- Identify sources of fixpacks, components that the fixpacks apply to, and methods to install fixpacks
- Identify courses and materials for additional problem determination training

Initial Problem Documentation

- **Gathering Initial Problem Documentation Data**
 - Information provided online
 - Reference books
 - Levels of support personnel
 - List of user environments
- **Is it Hardware?**
 - Any new hardware been added?
 - The hardware functioning?
 - Entries in the message log files indicating a hardware problem?
- **Is it Software?**
 - Problem associated with a program?
 - Nature of the problem?
 - System Error log indicate a software problem?
 - Problem Determination Tools -> System Error Log
 - SYSLOG command
 - Application error messages displayed?
 - System error messages displayed?

Installation Log Files (1 of 2)

Installation Log Files Created in \IBMINST\LOGS Directory

Subdirectory	Filename	File Contents
	CLNDESK.LOG	Desktop Shuffler log
	TOPINST.LOG	Top installation main log
\CONINST\	CONINST.LOG	Coninst log
\FEST\	LOCAL.LOG	FFST log
\IBMINST\	MKRSP.LOG	Building response file log
\TCPAPPS\	TCPINST1.LOG	TCP/IP log
\TCPAPPS\	TCPINST2.LOG	TCP/IP log
\LOCINSTU\	LOCAL.L2	Network product installation status, including log of products installed
\LS\	LOCAL.INS	LAN Server installation errors log
\LS\	LOCAL.SRV	LAN Server installation log
\MPTS\	LOCAL.MPT	MPTS installation log
\PSNS\	CIDERR.LOG	PSnS installation errors log
\PSNS\	CIDHIST.LOG	PSnS installation log
\BOOKS\	LOCAL.BKS	Books installation log
\NETSCAPE\	LOCAL.NET	Netscape installation log
\PPPSRV\	PPP.LOG	Remote Access Services installation log
\PPPSRV\	PPPCFG.LOG	Remote Access Services configuration log
\PSF\	LOCAL.LOG	Print Services Facility installation log
\PSF\	LOCAL.HST	Additional Print Services Facility installation log
\LCFAGENT\	LOCAL.LCF	Tivoli Management Aent (TMA) installation log
\LDAP\	LDAPERR.LOG	LDAP installation error log
\LDAP\	LDAPHST.LOG	LDAP installation log

Installation Log Files (2 of 2)

Installation Log Files Created in \IBMLAN\LOGS Directory

MESSAGES.LOG	LAN Server log
SCHED.LOG	LAN Server Log

Installation Log Files Created in \MMOS2\LOGS Directory

MINSTALL.LOG	Multimedia installation and configuration log
--------------	---

Installation Log Files Created in \OS2\INSTALL Directory

CD.LOG	Multimedia detection of CD-ROM information
CURRENT.LOG	Log of current installed items by feature install
DSPINSTL.LOG	Video display drivers log
FFSTINST.LOG	FFST log
IBMLSHST.LOG	LAN Server history log
INST_L1.LOG	Log created by Netscape
INSTALL.LOG	Base installation main log
LAPSHIST.LOG	MPTS history log
OS2MM.LOG	Multimedia detection of card, windows, etc.
TCPINST.LOG	TCP/IP log
WALINST.LOG	PPP Server installation module log
WINOS2.LOG	WIN-OS/2 installation path log
WPINSTAL.LOG	History log of installed items by feature install

Installation Log Files Created in \OS2\INSTALL\NETSCAPE Directory

NETSCAPE.LOG	Netscape installation log
--------------	---------------------------

Application-Specific Logs

- Application Documentation
- Net Error logs
 - Lan Server Error Log utility
 - NET ERROR </R /C:>
- POPUPLOG.OS2
 - SuppressPOPUPS=
- IBMCOM\LANTRAN.LOG
- IPE System Trap screen
- FFST
 - FFST setup
 - FFST documentation

Identifying Server Component Problems

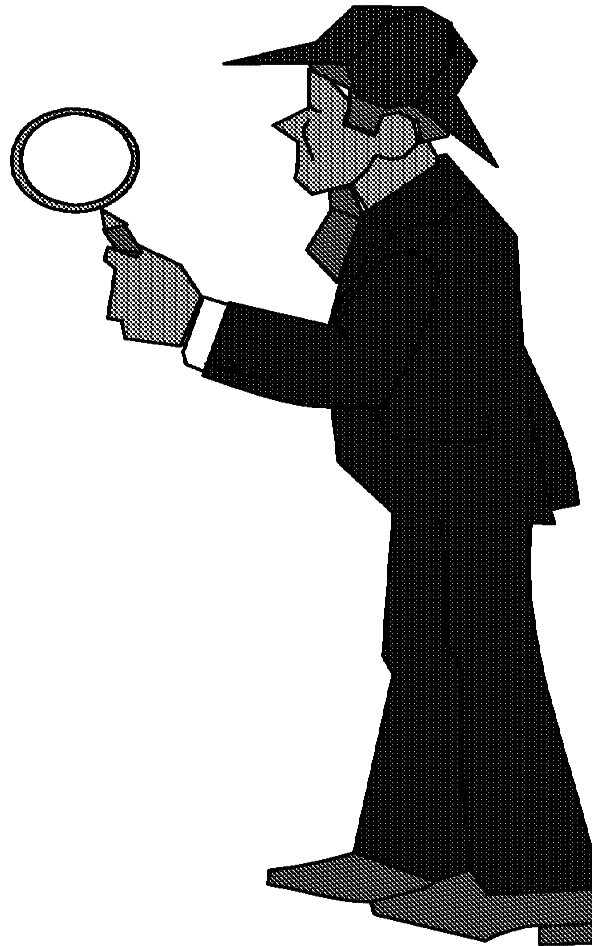

Determine Appropriate Technical Support

- Logs
- Messages
- Failure symptoms

Invoke Appropriate Support Assistance

- Invoke application supplier assistance
- Invoke IBM assistance

Information

- Config.sys
- Logs
- Messages
- Recreation

Contacts, Reporting, Logging

- Points of contact
- Tracking log
- Problem status

URLs

<http://www.austin.ibm.com/pspinfo/os2.html>

<http://ps.software.ibm.com/>

<http://www.service5.boulder.ibm.com/pspfixpk/nsf>

http://service.boulder.ibm.com/asd-bin/doc/en_us/catalog.htm

<http://www.developer.ibm.com/devcon/titlepg.htm>

<ftp://ftp.hursley.ibm.com/pub/java/fixes>

<http://www.software.ibm.com>

<http://www.software.ibm.com/OS/WARP/PRODUCTS/AURORA>

<http://www.software.ibm.com/OS/WARP/PRODUCTS/WARP-SERVER>

<http://service.software.ibm.com/os2ddpak/html/>

System Trace Facility

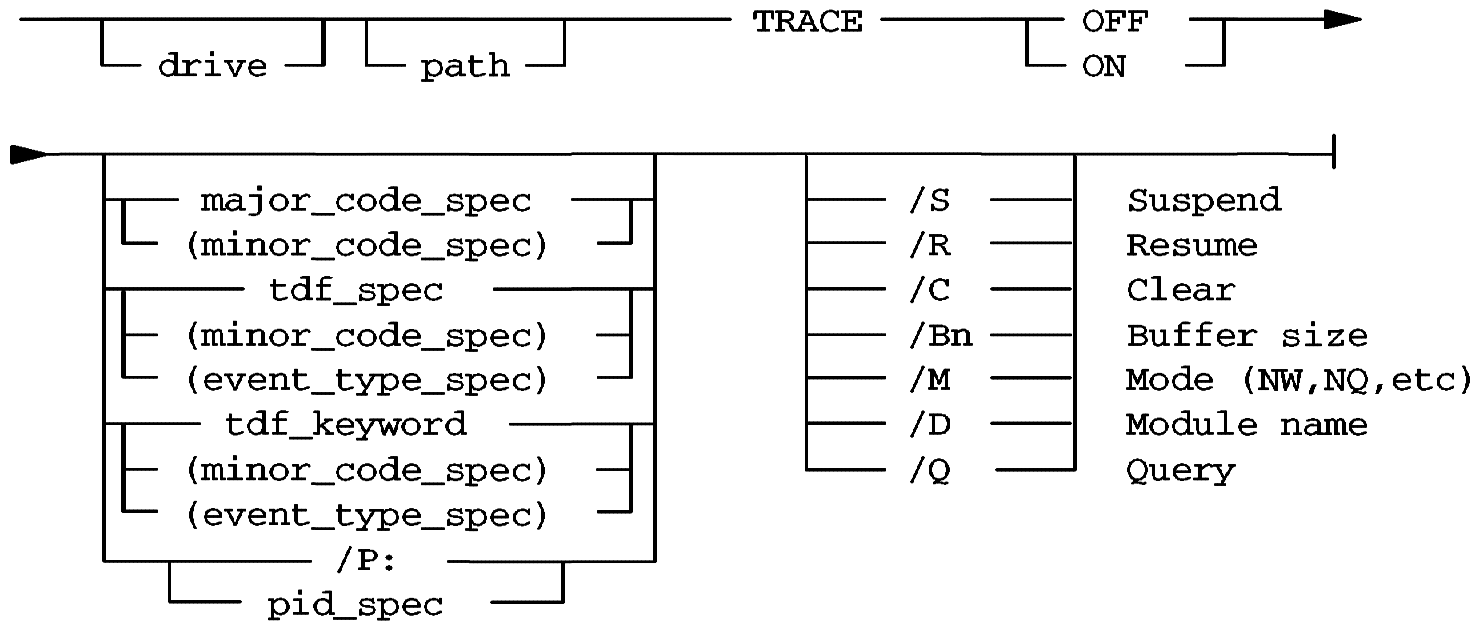

• **Related commands**

- TRACEBUF=
- TRACEFMT
- TRACEGET
- TRSPPOOL
- TRCUST
- PSTAT

Trace Point Types (1 of 2)

- Trace point types
 - STATIC TRACE points
 - DYNAMIC TRACE points
- Static Trace Points
 - API Call (DosSysTrace)
 - Machine Exceptions Major Code: 3
 - Hardware Interrupts Major Code: 4
 - Device Helper Routines Major Code: 6
 - Disk Device Driver Major Code: 7

Trace Point Types (2 of 2)

- **Dynamic Trace Points**
 - TDF files
 - TFF files
 - Inserted at instruction
 - Can be built for any DLL or application
 - System supplied
 - TRACE ON KERNEL(FS,LDR,NLS,PIP,SEL,SEM,SIG,TIM,TK,VM)
 - TRACE ON DOSCALL1(FS,LDR,LNK,MSG,MSP,NLS,SEM,TSK)
 - TRACE ON QUECALLS
 - TRACE ON SESMGR
 - TRACE ON OS2CHAR(KBD,MOU,VIO)
 - TRACE ON PMSHAPI
 - TRACE ON PMWIN
 - TRACE ON PMGRE
 - TRACE ON PMPIC
 - TRACE ON PMGPI

Groups

FS- file system
KBD- keyboard I/O
LDR- resource loader
LNK- environment management
MOU- mouse I/O
MSG- message management
MSP- virtual memory management
NLS- national language support
PIP- pipe support
SEL- selector-related
SEM- semaphore support
SIG- signal handling
TIM- timer support
TK- task management
TSK- monitor support
VIO- video I/O
VM- virtual memory management

Types

API- application programming interface

INT- internal

PRE- pre-processing invocation

POST- post-processing invocation

Strace Facility (Performance Tracing)

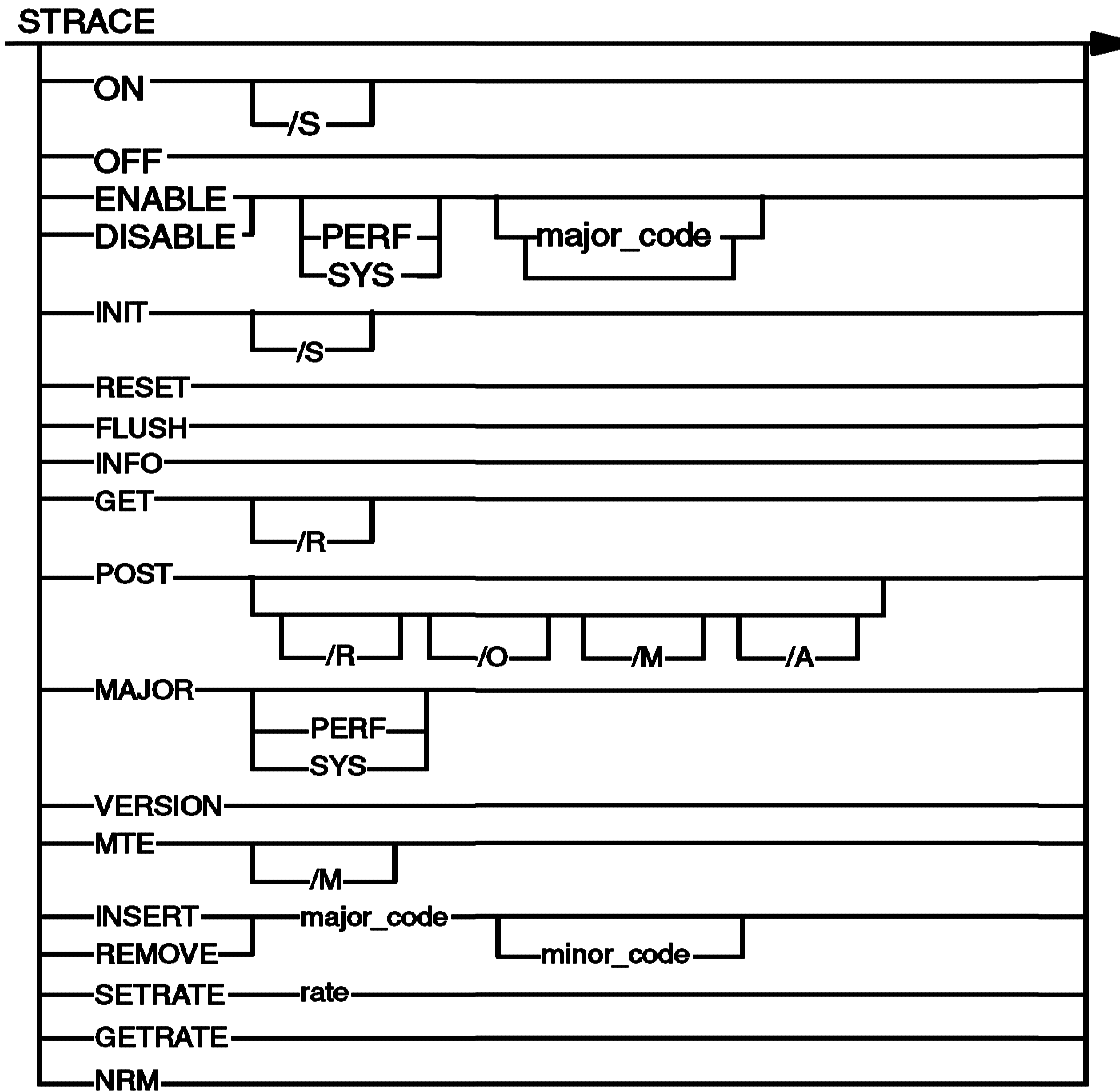

CONFIG.SYS

- CONFIG.SYS format
 - STRACE=INIT x
 - STRACE=ON
 - STRACE=ENABLE n1 n2 n3 ...
 - STRACE=DISABLE n1 n2 n3 ...
 - STRACE=INSERT n1 (SMP only)
 - STRACE=REMOVE n1 (SMP only)
- Trace Hooks
 - Exceptions and Interrupts
 - Dos (OS/2 Kernel) functions
 - DevHlp functions
 - Kbd functions
 - VIO functions
 - VDH functions
 - Vpic functions
 - WinOS2 functions
 - Internal Kernel related
 - Reserved for Customer

IPTRACE

IPTRACE [-i] [interface]

IPTRACE (all packets on all interfaces)
IPTRACE lan0 (all packets on lan0 interface)
IPTRACE -i (IP packets on all interfaces)
IPTRACE -i lan0 (IP packets on lan0 interface)

IPFORMAT [-a]
 [-d]
 [-e<opt>]
 [-f<file>]
 [-h]
 [-n]
 [-s<hwaddress>]
 [-x]

-a : Don't format ARP/RARP
-d : Don't display data portion
-e : Exclude <opt>: a (ARP), t (TCP), u (UDP), i (ICMP), g (IGMP)
-f : <input file> (default IPTRACE.DMP)
-h : Raw data after formatted info
-n : No hex data for unknown data
-s : ONLY format data for <hwaddress> (Source or Destination)
-x : Convert datafile to "Sniffer" format file

NETSTAT Command

```
.....  
.  
>>..netstat.....<<  
..-a.... Addresses of interfaces  
..-c.... ICMP stats  
..-i.... IP stats  
..-m.... Memory buffers  
..-n.... Interface information  
..-p.... ARP table contents  
..-r.... Routing table contents  
..-s.... Open sockets  
..-l.... Listening sockets  
..-t.... TCP stats  
..-u.... UDP stats
```

SMB Trace Tool

- HPFS386 SMB tracing
- HPFS386 File System traces
- Requester SMB tracing
- Netbios and 802.2 tracing
- Import sniffer trace files

Process Dump Facility

- Non-Intrusive
- Physical and Virtual memory
- Process selective

DUMPPROCESS=[Drive:\pppppp][/F=x]

PDUMPSYS.EXE - Set default data to be dumped for Ring 0

PDUMPUSR.EXE - Set default data to be dumped for Ring 2/3

PROCDUMP.EXE - Set data to be dumped for a specific process

PROCDUMP (1 of 2)

PROCDUMP [ON | OFF | FORCE | RESET | SET | QUERY]
[/L:<location>]
[/F:x] [/PROC:procnamelist]
[/PID:pidlist]
[/IPROC:procnamelist]
[/IPID:pidlist]
[/SYSTEM]
[/C:<x>]
[/P:<x>]
[/D:aaa, bbb]
[/K:<x>]
[/U]

PROCDUMP (2 of 2)

- PROCDUMP ON [/L:<location>] [/F:x]
- PROCDUMP FORCE [/PROC:procnames] [/PID:pids] [/SYSTEM]
- PROCDUMP OFF
- PROCDUMP RESET [/PROC:procnames]
[/PID:pids] | /PID:all]
[L] [F]
- PROCDUMP SET [/PROC:procnames]
[PID:pidlist]
[IPROC:procnamelist]
[IPID:pidlist]
[C:<x>] [P:<x>]
[D:aaa, bbb, PADDR(ALL)]
[K:<x>] [U]
- PROCDUMP QUERY

PDUMPSYS, PDUMPUSR

PDUMPSYS <one or more of the following >

PDUMPUSR <one or more of the following >

SUMM	- Summary information for each thread
SYSSUMM	- Summary information for all threads
IDT	- Interrupt Descriptor Table.
SYSLDR	- Loader data
SYSFS	- File System data
YSVM	- Virtual Memory data
SYSTK	- Task Management related data
PRIVATE	- Private code and data
SHARED	- Shared code and data
INSTANCE	- Instance data
MVDM	- MVDM instance data
YSMVDM	- MVDM data for all VDM and kernel
SEM	- Semaphore blocked threads
YSSEM	- SEM data all blocked threads in the system
KRHEAPS	- Kernel Resident Heaps.
KSHEAPS	- Kernel Swappable Heaps.
SYSPG	- Physical and Page Memory records
SYSIO	- IO subsystem structures
TRACE	- System Trace buffer(s)
STRACE	- STRACE buffer
ALL	- all of the previous mentioned options
LADDR(list of ranges)	- Dump a linear address range.
PADDR(list of ranges)	- Dump a Physical address range.
PADDR(ALL)	- Dump of all physical memory (system dump)
UPDATE	- allows adding additional options

System Dump Facility

TRAPDUMP= [OFF,Drive: | ON,Drive: | R0,Drive:] [,PD]

OFF - No automatic dumps

ON - System dump on either application or system failure

R0 - System dump on system failure only

Drive: - Diskette or HD Partition.

Partition requirements

- Size of ram plus 1-2 MB (minimum)
- Formatted FAT
- Volume lable of SADUMP
- Bios (Int 13) accessible
- Compatability lettering

Debug Kernel

- Kernels
 - Retail
 - Hstrict
 - AllStrict
- Hardware
 - Ascii Debug Terminal
 - null modem cable
 - or
 - Modem
- Optional
 - Symbol files
 - Trace Formatting files (TFF)

 - OS2LDR
 - PMDD.SYS
 - PMGRE.DLL
 - PMWIN.DLL

 - KDB.INI init control file

Installing Fixpacks

- Determine components
- Determine versions
- Determine sites
- Obtain fixpacks

Driver Updates (IBM and Third Party)

- Device
- Video
- Printer

Review Fixpack Information (Readme)

- Install considerations
- Operational considerations
- Additional features

Choose Install Method and Install Fixpacks

- **RSU (three flavors)**
- **Service**
 - Selectable drives
 - GUI
 - Deferred
- **FService**
 - All drives
 - VIO
 - Immediate (diskette or maint partition)
- **Archive and backup directories**
- **CID**
- **Removing old backups (commit)**
- **Reversion to previous levels**

Additional PD Training

- **Warp Debug Classes (SG24-4640 INF file)**
 - PS90/PS900 5 days
 - PS91/P1191 3 days
 - PS97/P1097 2 days
 - PS98/P1098 4 days
- **Lan Server PD Workshop**
 - IBM Austin
- **TCP/IP Architecture and PD**
 - S9107/G3740 3/2 days
 - S0260E/G3787 4/5 days
 - S0429E/G3861 3/3 days
 - NW043/NW430 3/3 days

Unit Summary

You should now be able to:

- Identify locations and purposes of various log files
- Identify references for various messages
- Analyze logs and messages to identify components related to the failure
- Disable autostart of server components and manually start each component in the proper sequence
- Resynchronize server passwords between Domain Controller (DC), backup DC and additional servers
- Identify appropriate support assistance (application, IBM, vendor, hardware, and so forth) and use proper channels to invoke that support
- Understand the purpose and setup requirements of system problem determination (PD) data gathering tools that may be required by support
- Identify sources of fixpacks, components that the fixpacks apply to, and methods to install fixpacks
- Identify courses and materials for additional problem determination training

